

**Operating manual**  
**Wascator FOM71 CLS**

*Thinking of you*

 **Electrolux**



# Register now

And be able to join the Wascator FOM 71 CLS web site where you can find:

- General information about Wascator FOM 71 CLS
- Updated installation-, operating- and service manuals and spare part lists.
- News about accessories and software updates.
- Operating and maintenance tip
- Possibility to personally ask specialists about the machine and its operation
- Hints about new standards related to the Wascator FOM 71 CLS.

You can send the registration via internet or fax.

## Via internet:

Enter [www.electrolux.com/laundrysystems](http://www.electrolux.com/laundrysystems) and select "New user" up in the right corner.

Fill in all required information marked with an \*.

In the field "Comments" fill in the code word "Wascator FOM 71 CLS" and your machines product number and serial number.

(You can find the product number on the inside of the door frame or at the data sign at the rear side of the machine).

*Within 24 hours you shall receive a personal code word so you can enter the Wascator FOM71CLS web site.*

## Via fax:

If you prefer to register via fax please send in the information below.

Send fax to:

---

**Electrolux Attention S H Almstrom Fax number +46 372 133 90**

*Registration for the Wascator FOM 71 CLS web site*

Company: .....

Contact person: Surname .....

First name .....

Mr/Ms .....

Company adress: .....

Zip code: .....

City: .....

State: .....

Country: .....

Phone: .....

Fax: .....

e-mail address: .....

Wascator FOM 71 CLS product number: .....

Wascator FOM 71 CLS serial number: .....



# Contents

---

## Contents

Procedure for use .....	9
General introduction .....	9
Preparations .....	10
The "Move back" key .....	11
To start the wash program .....	11
Program description .....	15
To start a wash program from the program library .....	16
To change parameters in the current program step .....	19
Rapid advance .....	20
Show weight .....	22
No water reduction .....	23
Pause .....	24
Manual operation during a program .....	25
Text .....	31
To change the wash program after program operation has commenced .....	32
To change temperature .....	33
Auto restart .....	34
Manual operation .....	35
To select manual operation .....	35
Motor/door .....	36
Water/drain .....	37
Heating .....	38
Detergent signals and water flushing .....	39
Statistics .....	40
To select statistics .....	40
Resetting statistic registers .....	42
Scale .....	47
Memory card .....	58
General introduction .....	58
To select the "Memory card" function .....	59
To run a wash program straight from a memory card .....	62
To copy a program from a memory card to the machine's program control unit .....	63
To copy a program from the program control unit to a memory card ....	66
To delete a program on a memory card .....	69
To delete all programs on a memory card .....	70
Maintenance .....	71
Calibration of level control system .....	72
Calibration of the scale (weight function) .....	77
Calibration of the reference machines Wascator FOM71CLS .....	78
Checklist for calibration of Wascator FOM71CLS .....	78
Cheks to be made .....	79
Door opening for test sample Wascator FOM71CLS .....	82
Calibration protocol .....	83



# Safety



## Safety

**This machine can only be used with water. Never use dry cleaning agents.**

**Do not allow children to operate the machine.**

**Do not hose down or spray the machine with water.**

**All mechanical and electrical installation must be carried out by qualified personnel.**

**The machine's door lock must not be bypassed and it should be checked daily to ensure it functions.**

**Should the machine malfunction, please report the fault to the technician responsible for the machine.**

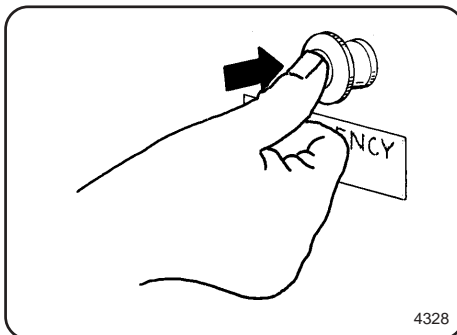

### Emergency stop

If the machine for some reason has to be stopped – press emergency stop button

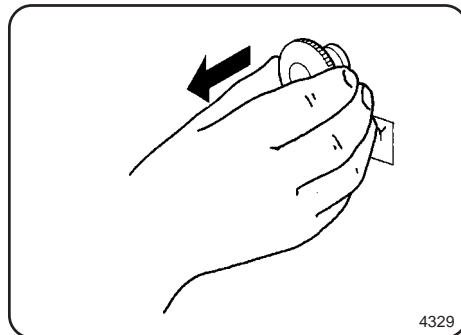

When necessary measures have been taken, the emergency button can be reset by pulling it out.

The manufacturer reserves the right to make changes to design and component specifications.

**NOTE! Some of the display texts and functions may not appear on your machine version.**





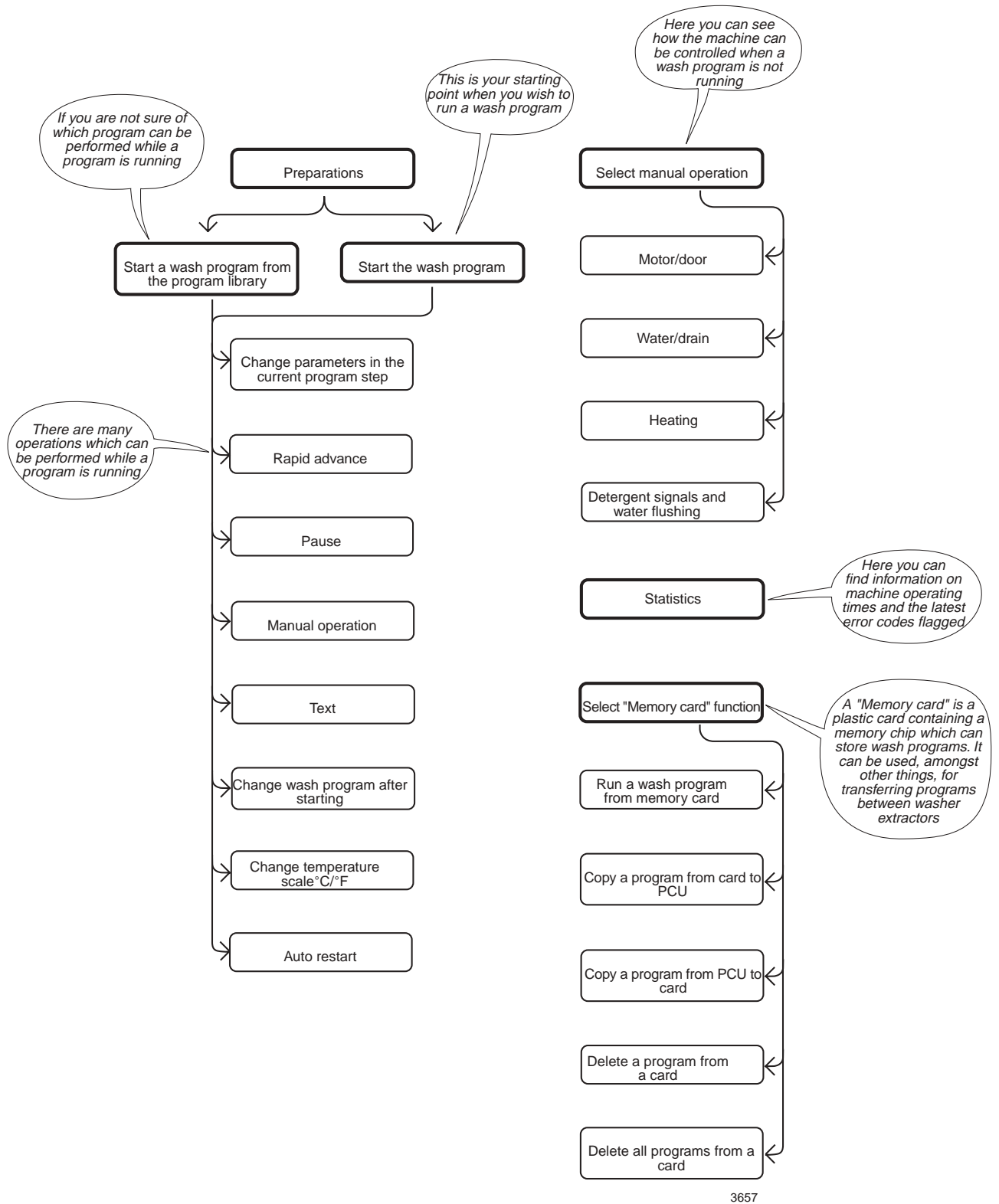

3657



## Note



### **Weight calibration (only Wascator FOM71 CLS)**

If the value in the display shows more than  $\pm 0.1$  kg, reset scale to zero.

### **Level calibration**

Check and calibrate if a longer test serie is to commence.

## General introduction

**Fig. 1** This washer extractor is controlled by a microprocessor-based program control unit. There are many advantages to this equipment, including:

- timing, levels and temperatures are controlled with great precision and flexibility
- detailed information on wash programs, machine status and operations, wash times and temperatures can be accessed in plain language on the large display screen
- it is possible for the user to create new wash programs, and to adapt programs precisely on the basis of experience and to suit various types of textile, degrees of soiling etc.
- a very high level of machine safety through continuous monitoring and built-in safety interlocks
- the program control unit has a reader for "memory cards". These are cards the size of a credit card which contain a memory chip. Memory cards allow the user to:
  - transfer wash programs between a PC and the washer extractor, or from one washer extractor to another
  - run programs straight from a card
- great flexibility during program operation:
  - rapid advance both forwards and backwards in the program
  - change temperatures, program module lengths and extraction speeds directly, during program operation
  - start a different program at any time during program operation.

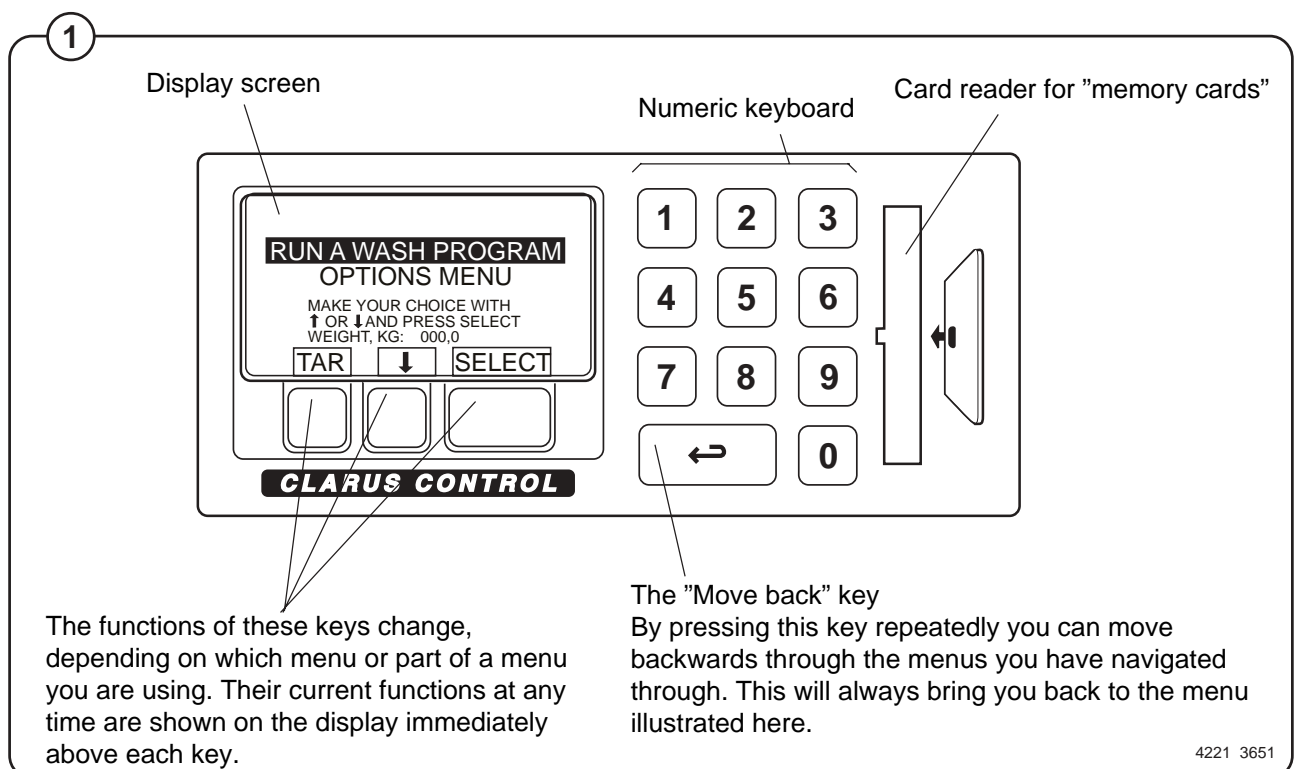

## Preparations

- Sort the load, paying attention to the textile care labels on the items. Empty all pockets and do up zip fasteners.
- Open the machine door, check that the drum is empty, load the items into the machine and close the door.
- Check that the emergency stop button has not been pressed inwards (see "Machine safety").

## Measuring the detergent

Fig. 2  
2

Compartment 1 – pre wash, powder or liquid detergent

Compartment 2 – main wash, powder detergent

Compartment 3 – softener

**(Note! When using weight control softener can not be used (compartment 3 will be used for dosing water in all baths).**

Compartment 4 – main wash, liquid detergent

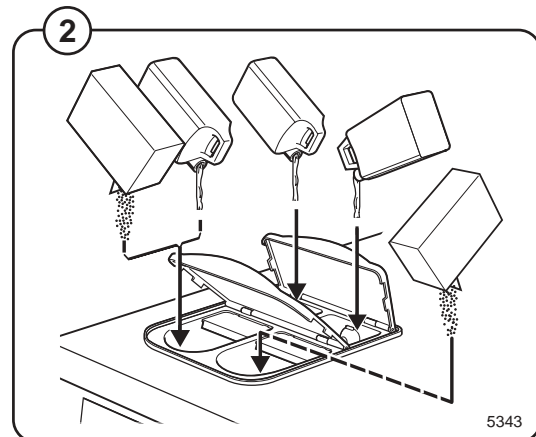

The "Move back" key



3627

If you find you are in the wrong place, or if you want to undo earlier key presses:

Press the "Move back" key one or more times.

The "Move back" function

Each press of the "Move back" key moves you back one menu, in reverse order. By pressing this key repeatedly you can return to this menu at any time:



3651

To start the wash program



3580

If this menu is not currently displayed:

Press  repeatedly.



If "GO TO THE MENU" is highlighted:



Press .



When "RUN A WASH PROGRAM" is highlighted:



Press SELECT.

Two ways of starting a program

By entering the actual program number

Enter the actual program number if you know it, then press SELECT.

By starting from the program library (see section "To start a wash program from the program library")

If you are unsure about the programs available, you can select a program from the program library, where the programs are listed with their descriptions.

# Procedure for use

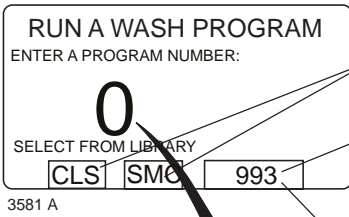

Here you can select programs from the program libraries. See the section entitled "To start a wash program from the program library".

Displayed here will be the number of the most frequently used program. S993 would indicate the number of a program on a memory card.

**Press this key if you want to select this program.**

for example: **91**

**SELECT**

Use the numeric keys to enter the program number. Press **SELECT**.

***If you have entered the wrong number***

Enter the correct number to overstrike the earlier one.

**Note:** you must always enter three digits, even when the number is really only a one or two-digit number.

Examples:

The program number required is **9**. Enter **009** to overstrike all digits in the wrong number.

The program number required is **19**. Enter **019** to overstrike all digits in the wrong number.

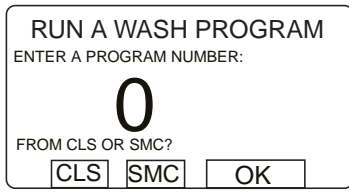

If you have a memory card in the program control unit, and the program you selected is both on the memory card and in the PCU, you will be asked "FROM CLS OR SMC?".

**CLS**

**Press CLS if you want to take the program from the PCU.**

**SMC**

**Press SMC if you want to take the program from the memory card.**

In some of the text shown on the display, Clarus Control is referred to as CLS and the memory card is referred to as SMC.

***Memory cards***

A memory card is a plastic card, the size of a credit card, with an electronic memory chip inside it. This card is capable of storing 10 to 15 wash programs of normal size. If the programs are mostly small ones, more of them can be stored, whereas larger programs will reduce the number which can be held by the card. Memory cards of this type can be used to:

- transfer wash programs from one washer extractor to another
- run wash programs straight from the card
- transfer wash programs from a PC to a memory card and from a memory card to a PC (these procedures, and how to write a wash program on a PC, are described elsewhere).

Memory cards are described in detail in the section entitled "The Memory card".



3582

Delayed start time (hrs:mins)  
Program name

If you want to see the description of the program:



Press **TEXT**.

**Pressing "Text" displays more information**  
The text displayed is a description of the wash program selected. This text description is inserted when a new wash program is created. This procedure is described fully in the programming manual.

①



**Choose 1 or 2:**  
1 To start the program now:  
**Press START.**

②



2 **Delayed start**  
**Use the numeric keys to enter a time (max. 99 hrs). This parameter appears on the right of the display.**

**Delayed start**  
Delayed start means that the machine will not start the wash program until the time entered has elapsed.  
This function allows you, for example, to load the machine in the evening, but delay the start of the wash until early the next morning, to end in time for the next shift.



**Press START.**

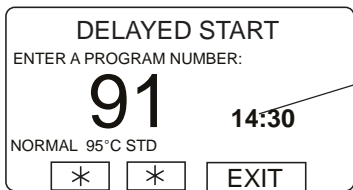

Time left before the machine is to start



If you want to cancel the delayed start:  
**Press EXIT**



3627

During a wash program:  
**Press  to make the machine pause during the wash program.**

**Two ways of pausing during a wash program**  
There are two ways of pausing during a wash program:  
1 By pressing .  
2 As an additional function. This is described in section "Pause".

# Procedure for use

The following information is displayed during the wash program:

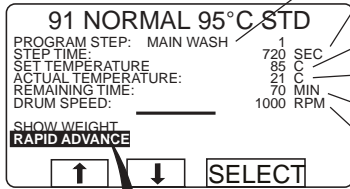

- Current program step
- Time left for this program step
- Set temperature
- Actual temperature
- Remaining program time
- Drum speed

- To terminate a program before it has finished**
- Select RAPID ADVANCE and press SELECT. Advance to "END OF PROGRAM" and press SELECT.
  - Wait until "READY TO UNLOAD" appears on the display.
  - Now the door can be opened.

3583

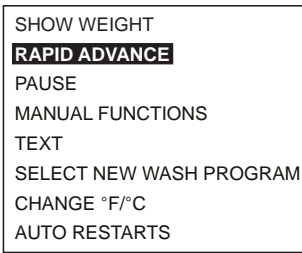

If required:



Select a **function** using the cursor keys.



Press **SELECT**.

### Additional functions during the program

**Rapid advance (see section "To change parameters in the current program step")**

Rapid advance through the program to the program step required. Rapid advance can be used to move both forwards and backwards through the program.

**Display weight (see section "Show weight")**

The actual load weight is shown in large digits on the display (weight display mode). (On machines with weighing equipment only.)

**No water level reduction (see section "No water level reduction")**

Machines with weighing equipment installed adjust the water level automatically according to the load weight. This function lets you switch off water level reduction during the current program.

**Pause (see section "Pause")**

The machine stops. The drain valve remains closed. Another way to pause the program: Press .

**Manual functions (see section "Manual operation during a program")**

The following functions can be controlled manually during the course of the program:

- all water valves, drain and pumps (where applicable).
- limit highest extraction speed.
- motor on/off after end of wash program.
- flush detergent.

**Text (see section "Text")**

Display description of wash program (if available).

**Select a different wash program (see section "To change the wash program after program operation has commenced")**

You can switch to using a different wash program at any stage during the wash. Once this function has been selected, the current step (for example, rinse) of the earlier program will be allowed to finish and then the new program will start (from the beginning).

**Change temperature scale °C or °F (see section "To change temperature scale °C/°F")**

**Auto restart (see section "Auto restart")**

Here you enter the number of times you wish the wash program to restart automatically.



## Program description

The following programs are fixed programmes in memory.

Prgr.no.	Name	Contents/Application
991	Start-up program	If the machine has been idle more than two hours, this program should be run before any other program is run.
992	Level check	Check with ruler insider  Program fills machine with water to a reference level at 160 mm, maintains this level 20 seconds and press PAUS and it empties the machine. This process is repeated five times. After that, the program fills machine with water to the following levels one after the other: 100 mm, 130 mm, 160 mm and 200 mm. Each level is maintained 40 seconds before emptying.
993	Weight check	Program fills the machine with water to 18 kg, wait 30 seconds, rotates 60 seconds and fills to 26 kg (+8) and waits 30 seconds. Then drain.
994	Temperature check	Program fills machine with water to 130 mm level and warms it in five steps: 25°C for 2 minutes, 40°C for 2 minutes, 60°C for 2 minutes, 80°C for 2 minutes and 90°C for 2 minutes. The machine is emptied, filled twice with cold water to a high level 200 mm and finishes with a two minute spin cycle 1000 rpm. The buzzer sounds at the end of the program.
995	Low extraction 500 rpm 1 minute.	
996	Low extraction 500 rpm 5 minutes.	
997	Extraction 775 rpm 2 minutes (15s 550)	
998	Extraction 950 rpm 4 minutes (15s 550 + 15s 775)	
999	High extraction 1100 rpm 5 minutes (15+15+20s 950)	

## To start a wash program from the program library

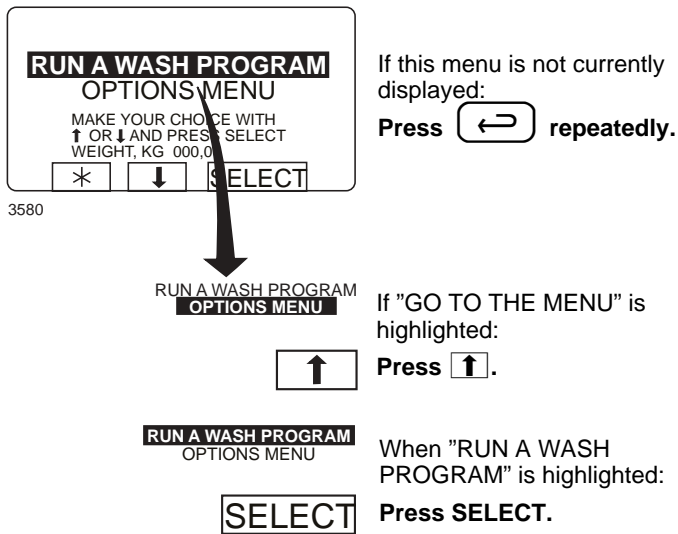

### What is the program library?

The program library lists all wash programs, both user and standard programs, showing their program numbers and a description, for example:

1	MY OWN 40 °C
2	MY OWN 60 °C
3	MY OWN 90 °C
991	Start-up program
992	Level check
993	Weight check
994	Temperature check
995	Low extraction 500 rpm 1 minute
996	Low extraction 500 rpm 5 minutes
997	Extraction 775 rpm 2 minutes (15s 550)
998	Extraction 950 rpm 4 minutes (15s 550 + 15s 775)
999	High extraction 1100 rpm 5 minutes (15 + 15 + 20s 950)

Each time a new program is stored in the machine program memory, its number and description will be inserted automatically into the program library.

The program library may be used for starting a wash program, but is also used in programming, when a wash program needs to be modified or if a new program is to be created on the basis of an existing one.

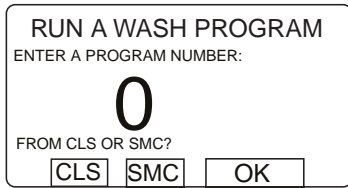

4031 A

To select a program from the PCU program library:

**Press CLS.**



If there is a memory card in the PCU and you wish to select a program on that:

**Press SMC.**



**Select library via menu**

You can also select the program library via the option "GO TO THE MENU". Then select "WASH PROGRAM LIBRARY".

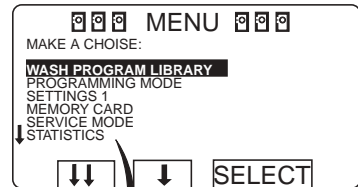

3590

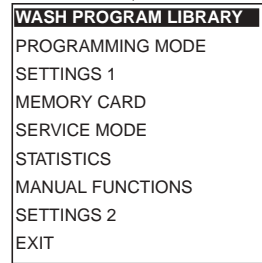

# Procedure for use



3582

Delayed start time  
(hrs:mins)  
Program name

If you want to see the description of the program:



Press **TEXT**

**Pressing "Text" displays more information**

The text displayed is a description of the wash program selected. This text description is inserted when a new wash program is created. This procedure is described fully in the programming manual.

**Choose 1 or 2:**

1



1 To start the program now:  
Press **START**.

2



2 **Delayed start**  
**Use the numeric keys to enter a time (max. 99 hrs). This parameter appears on the right of the display.**

**Delayed start**

Delayed start means that the machine will not start the wash program until the time entered has elapsed.  
This function allows you, for example, to load the machine in the evening, but delay the start of the wash until early the next morning, to end in time for the next shift.



Press **START**.

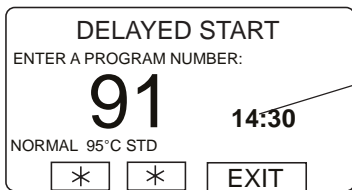

Time (in hours and minutes) left before the machine is to start.

If you want to cancel the delayed start:  
Press **EXIT**.



The functions which are available during program operation are described in sections "To change parameters in the current program step - Auto restart".

## To change parameters in the current program step

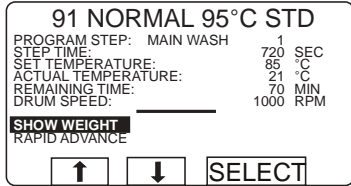

3584

During program operation the display will look like this (see section "To start the wash program").

**You can alter the following program steps:**

**Prewash, Main wash, Rinse, Drain, Soak**  
Length of program step (max. 9998 seconds), heating temperature (max. 97°C).

**Extraction**  
Length of program step (max. 3599seconds), extraction speed.



Press  one or more times...

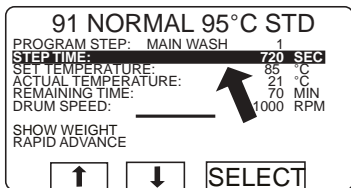

...to highlight the line required.

**SELECT**

Press **SELECT**.



Use the numeric keys to enter the new **parameter**.

**SELECT**

Press **SELECT**.

**If you have entered the wrong parameter**

Continue pressing numeric keys to overstrike the incorrect parameter.

**Note:** always use the same number of digits as used on the display to overstrike the incorrect parameter.

Example:

To change the time for the program step to **30** seconds, enter **030** to overstrike the earlier parameter.

## Rapid advance

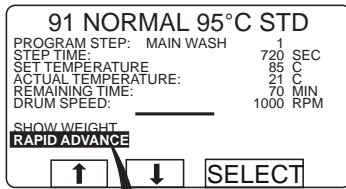

3583

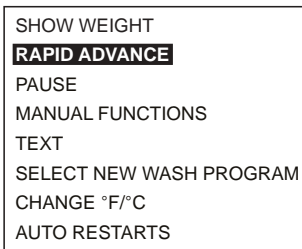

During program operation the display will look like this (see section "To start the wash program").

Check that "RAPID ADVANCE" is highlighted.



If it is not highlighted:  
 Press [UP] or [DOWN] one or more times to highlight "RAPID ADVANCE".



Press SELECT.

### To terminate a program before it has finished

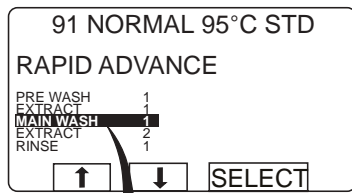

- Select RAPID ADVANCE and press SELECT. Advance to "END OF PROGRAM" and press SELECT.
- Wait until "THE DOOR IS UNLOCKED" appears on the display.
- Now the door can be opened.



3586

PRE WASH	1
EXTRACT	1
<b>MAIN WASH</b>	<b>1</b>
EXTRACT	2
RINSE	1
EXTRACT	3
RINSE	2
EXTRACT	4
RINSE	3
EXTRACT	5
END OF PROGRAM	





Press  or  one or more times to highlight the program step you wish to advance to.



Press SELECT.

**Rapid advance works in both directions**

Rapid advance works in both directions, using  and .

Using rapid advance to move forwards allows you to skip one or more program steps. Using rapid advance backwards allows you to repeat one or more program steps.

**Automatic return to normal display**

Once you have selected any of the functions below, you must make any changes required within 20 seconds. If no further keys are pressed within 20 seconds, the display will revert automatically to its normal appearance during a wash program.

# Procedure for use

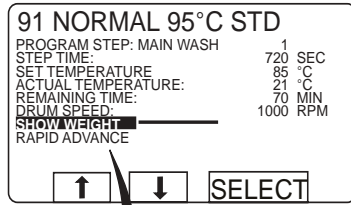

For machines with weighing equipment installed only!

## Show weight

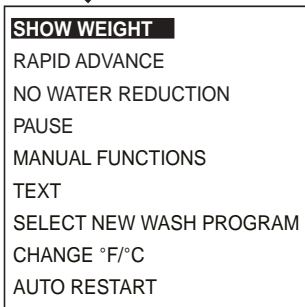

4774



Press  or  one or more times to highlight "SHOW WEIGHT".



Press SELECT.



4775

Weight display mode:

The actual net weight is shown in large digits on the display.

### Show weight

The actual weight is shown in large digits on the display (weight display mode).

If the weighing equipment is not connected, the error message "FUNCTION NOT ALLOWED" will appear. See the section "Fault-finding, weighing equipment" in the machine manual.

### Return to normal display

The display will return to normal at the end of the "time for weight display" set as a parameter in Settings 1. The manufacturer's default parameter is 20 seconds.

### To end weight display sooner

Press  or use the numeric keys to enter a new program number.



For machines with weighing equipment installed only!

## No water reduction (not for Wascator FOM71 CLS)

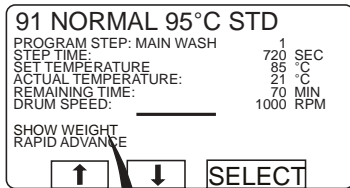

4776

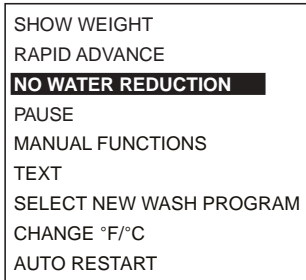



During program operation the display will look like this (see section "To start the wash program").

### *No water reduction*

The wash load is weighed during the program and the water level is adjusted automatically according to its weight. If the load is not a full one, the water level will be reduced according to a water level reduction table. You can switch off water level reduction at any stage of a program.

Note that if you select "NO WATER REDUCTION", this applies only to the program currently running. The next time a program is started, water level reduction will occur automatically again.



Press  or  one or more times to highlight "NO WATER REDUCTION".



Press SELECT.

## Pause

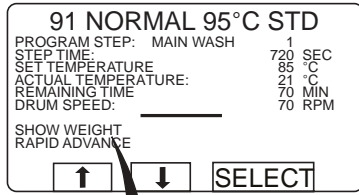

3587

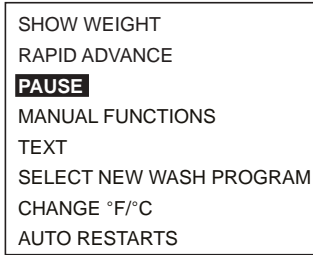

During program operation the display will look like this (see section "To start the wash program").

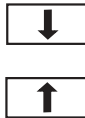

Press or one or more times to highlight "PAUSE".



Press SELECT.

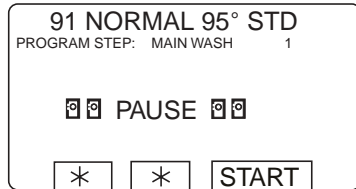

3588



Press START to restart the wash program.

### Two ways of pausing during a wash program

Note that you must be in normal wash mode to be able to pause in this way. If, for example, you are using "Manual Functions", you will have to exit that first before you can use Pause.

There are two ways of pausing during a wash program:

- 1 As an additional function. This is described in this section.
- 2 By pressing .

### When the machine pauses:

- Program operation is halted.
- Filling is halted (where applicable).
- Heating is halted (where applicable).
- The motor stops.
- The drain valve remains closed.
- The door cannot be opened.

## Manual operation during a program

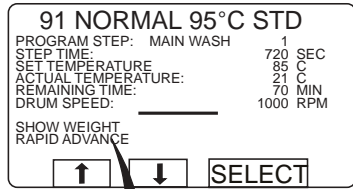

3585

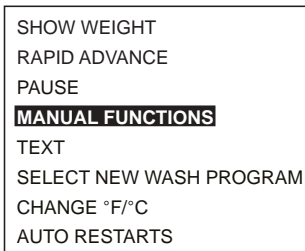

During program operation the display will look like this (see section "To start the wash program").

### Two types of manual operation

There are two types of manual operation, which should not be confused:

- **Manual operation during a program**  
These functions are described in this section.
- **Manual operation when no program is running**  
These functions are described in section "Manual operation".



Press ↑ or ↓ one or more times to highlight "MANUAL FUNCTIONS".



Press SELECT.

# Procedure for use

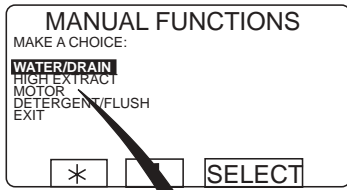

3679

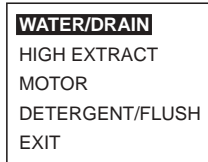

Use the cursor keys to select the function.



Press SELECT.

### Automatic return to normal display

Once you have selected any of the functions below, you must make any changes required within 20 seconds. If no further keys are pressed within 20 seconds, the display will revert automatically to its normal appearance during a wash program.

### Manual functions during a wash program

- Water/drain (see section "Water/drain")**  
Allows manual operation of all water valves and the drain valve.
- Highest extraction speed (see section "Maximum extraction speed")**  
Here you can limit the maximum extraction speed for the current program.
- Motor (see section "Motor on after wash")**  
Motor on/off after program has ended.
- Detergent valves (see section "Detergent signals and water flushing")**  
Allows you to control all valves in the detergent compartment or in external detergent supply system.

Water/drain

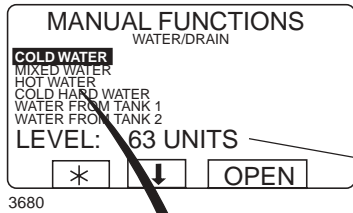

To access this function, see instructions in section "Manual operation".

Water level in drum



Use  and  to select the water/drain option you require.

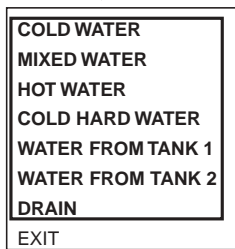

Press OPEN. The function will be activated for as long as you press and hold this key. The function ceases as soon as you release the key.

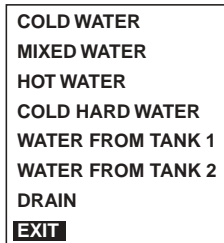

When you have finished: Press  repeatedly to highlight "EXIT".



Press SELECT.

# Procedure for use

## Maximum extraction speed

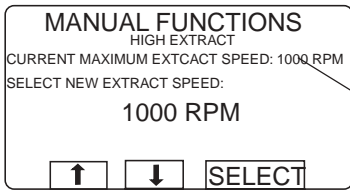

3681

To access this function, see instructions in section "Manual operation".

Maximum extraction speed in current program.



Enter the maximum extraction speed you require for this program.



Press SELECT.

### To limit the program's highest extraction speed

This function allows you to modify the highest extraction speed allowed during the program.

Example:

Assume that the highest speed in the program is 1000 rpm and that you have set 700 rpm as the highest speed allowed.

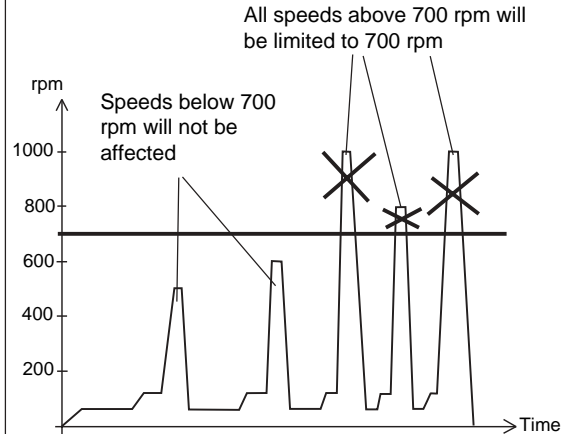

3682

This change will affect the current program only. No change will be implemented if extraction is taking place at the time of the (attempted) change. The next time that this program is used, the original maximum speed will apply.

This function does not allow you to set a **higher** speed than the usual maximum speed for the program.

Motor on after wash

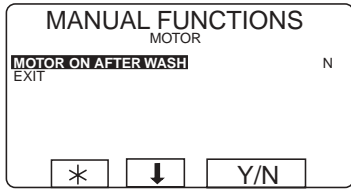

3683

To access this function, see instructions in section "Manual mode".



A toggle function: Use Y/N to toggle the function from ON (Yes) to OFF (No).



When you have finished: Press ↓ to highlight "EXIT".



Press SELECT.

**Motor to rotate after program has ended**

If you answer **Yes (Y)**:

The motor will continue to rotate in alternative directions after the program has ended. This prevents creasing of the load.

When the program has ended, the display will look like this:

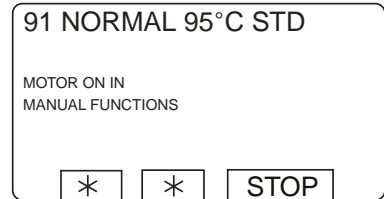

4111

Press STOP to stop the motor.

## Detergent signals and water flushing

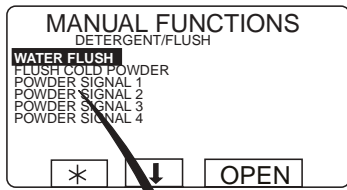

3684

To access this function, see instructions in section "Manual mode".

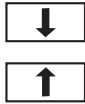

Use ↓ and ↑ to select the function you require.

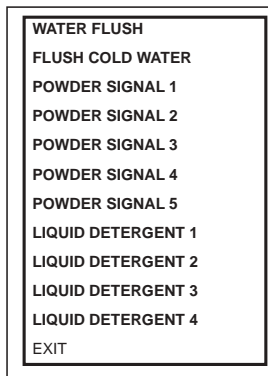

**Detergent signals and water flushing**

**FLUSH WATER:**  
This function uses water to clear detergent from the supply tubes of the detergent dispensing system.

**POWDER SIGNAL:**  
This function will either: a) use water to dispense detergent from machine compartments, or: b) dispense detergent from an external system. The number of valves present will vary according to the machine type.



**Press OPEN.**  
The function will be activated for as long as you press and hold this key. The function ceases as soon as you release the key.

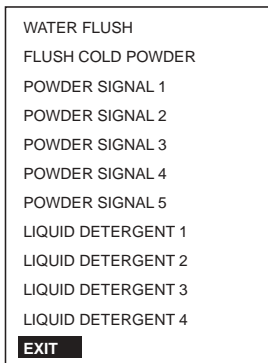

When you have finished:  
**Press ↓ repeatedly to highlight "EXIT".**



**Press SELECT.**



## Text

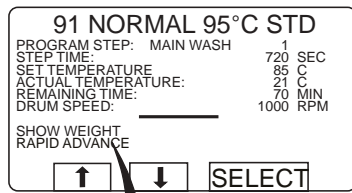



During program operation the display will look like this (see section "To start the wash program").

### Pressing "Text" displays more information

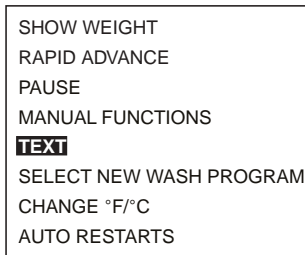
The text displayed is a description of the wash program selected. This text description is inserted when a new wash program is created. This procedure is described fully in the programming manual.



Press  or  one or more times to highlight "TEXT".



Press SELECT.

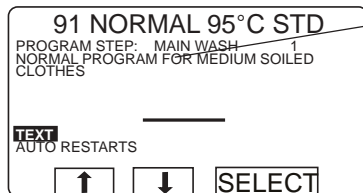

Description of wash program



To return to the normal display: Press  again.

### Automatic return to normal display

If you do not press SELECT within 20 seconds, the display will revert automatically.

## To change the wash program after program operation has commenced

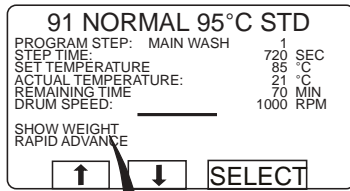

3694

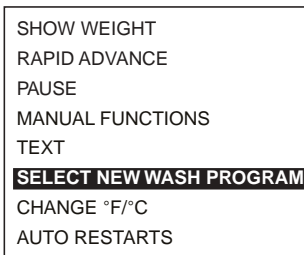



During program operation the display will look like this (see section "To start the wash program").

### To change the wash program after program operation has commenced

You can change to a different wash program at any time during program operation. When you do, the current function (for example, rinse) will be interrupted. The new program will start immediately after that (from the beginning).

This function is useful, for example, if you discover that you have started the wrong program.



Press  or  one or more times to highlight "SELECT NEW WASH PROGRAM".



Press SELECT.

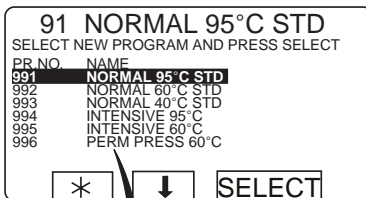

3695



Press  one or more times as required...

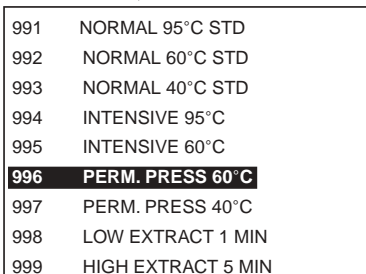

...to highlight the new wash program.



Press SELECT.

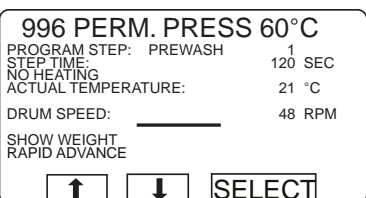

The existing wash program will now be interrupted and the new one will begin.

### Automatic return to normal display

If no key is pressed within 20 seconds, the display will revert automatically.

### What is the program library?

The program library lists all wash programs, both user and standard programs, showing their program numbers and a description, for example:

1	MY OWN 40 °C
2	MY OWN 60 °C
3	MY OWN 90 °C
991	Start-up program
992	Level check
993	Weight check
994	Temperature check
995	Low extraction 500 rpm 1 minute
996	Low extraction 500 rpm 5 minutes
997	Extraction 775 rpm 2 minutes (15s 550)
998	Extraction 950 rpm 4 minutes (15s 550 + 15s 775)
999	High extraction 1100 rpm 5 minutes (15 + 15 + 20s 950)

Each time a new program is stored in the machine program memory, its number and description will be inserted automatically into the program library.

The program library may be used for starting a wash program, but is also used in programming, when a wash program needs to be modified or if a new program is to be created on the basis of an existing one.

## To change temperature scale °C/°F

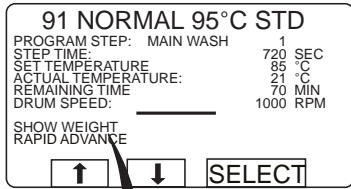

3696

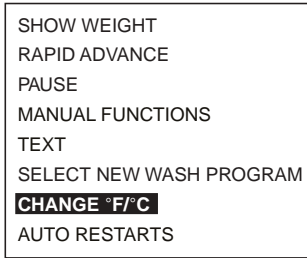

During program operation the display will look like this (see section "To start the wash program").



### To change temperature scale °C/°F

This function changes the temperature scale used for all temperatures displayed during the wash program.

Please note that this scale change applies only to the current program. The default temperature scale will apply next time you run a program.

To change the default temperature scale for all programs, use the function "SETTINGS", which is described in the Service Manual.



Press  or  one or more times to highlight "CHANGE °C/°F".



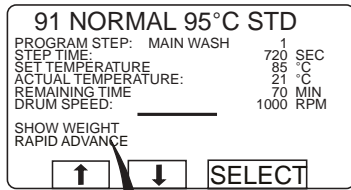

Press SELECT.

## Auto restart

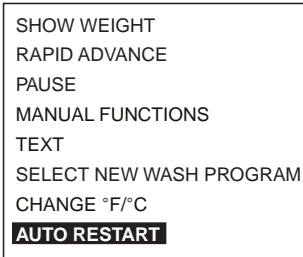

3593



Press  one or more times to highlight "AUTO RESTART".



Press SELECT.

### What is Auto restart?

Auto restart means that the same program will be repeated one or more times, according to the number set. The program will restart immediately, and the door will remain locked. If you have set auto restart, the display will show the number of restarts left.

This function is used primarily for testing.

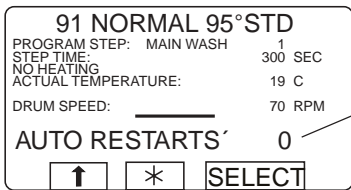

3594

Shows the number of times the program will restart.

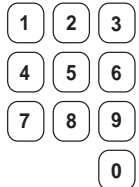

If required:  
Use the numeric keys to change the required number of restarts.



Press SELECT.

## Manual operation

### To select manual operation



3589

If this menu is not currently displayed:  
Press repeatedly.



Press to highlight "GO TO THE MENU".

Press SELECT.

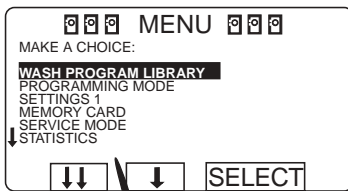

3685

Press six times...

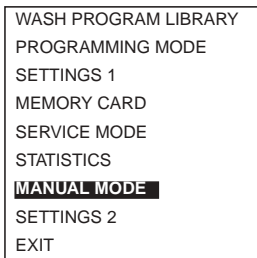

....to highlight "MANUAL MODE".



Press SELECT.

### Two types of manual operation

There are two types of manual operation, which should not be confused:

- **Manual operation when no program is running**  
These functions are described in this section.
- **Manual operation during a program**  
These functions are described in **section "Manual operation"**.

### Always lock the door first!

You must always close and lock the door first before you can operate the machine manually.

To lock the door, use the submenu MOTOR/DOOR, see section "Motor/door".

### All manual settings are cancelled when you exit manual operation

All manual settings (such as door, motor, temperature, and drain) will be cancelled when you exit manual operation.

The door is unlocked, the motor stops, the drain opens, heating is halted, and the temperature is reset to zero.

## Manual operation

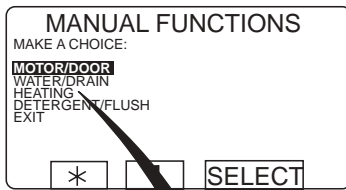

3686

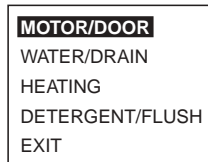

Select the **function** required using the cursor keys.



Press **SELECT**.

### *Manual operation when no program is running*

#### **Motor/door (see section "Motor/door")**

Lock/unlock door. Switch motor on/off (normal drum action).

#### **Water and drain valves (see section "Water/drain")**

Operation of drain valve and all water valves.

#### **Heating (see section "Heating")**

Heat water to any temperature required.

#### **Detergent valves (see section "Detergent signals and water flushing")**

Allows manual operation of all valves in detergent compartment or external detergent supply system.

#### **Exit**

Returns you to the MENU display.

## Motor/door

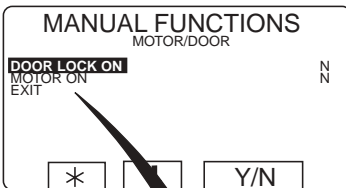

3687



Press **↓** as required to select a function.



A toggle function:

Use **Y/N** to toggle the function from **ON (Yes)** to **OFF (No)**.



When you have finished:

Press **↓** to highlight "EXIT".

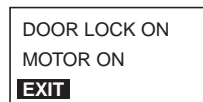

Press **SELECT**.

### *Lock the door and start the motor*

#### **DOOR LOCK ON**

If you answer **Yes (Y)**:

The door will be locked. Note that you must always lock the door before you can operate the machine manually.

#### **MOTOR ON**

If you answer **Yes (Y)**:

The motor will start and operate, using normal action.

## Water/drain

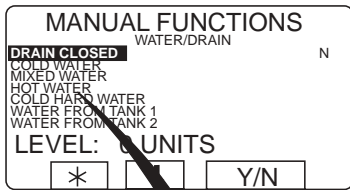

3688

To access this function, see instructions in section "To select manual operation".



Use or to select Drain or one of the six Water filling alternatives.



Not for Wascator FOM71 CLS

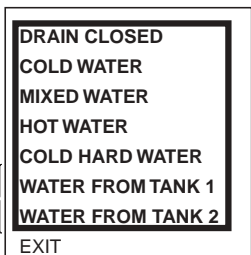

Drain (a toggle function) :  
Press **Y/N** to toggle the function from Yes (Y) and No (N).



Water filling:  
Press **OPEN**.  
The function will be activated for as long as you press and hold this key. The function ceases as soon as you release the key.



When you have finished:  
Press to highlight "EXIT".

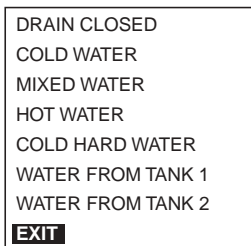

Not for Wascator FOM71 CLS



Press **SELECT**.

## Heating

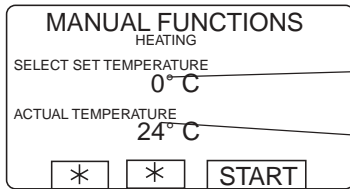

3689

To access this function, see instructions in section "To select manual operation".

Temperature selected

Actual temperature



**Use the numeric keys to enter the temperature the water is to be heated to.**



**Press START.**  
Heating will now begin.



If you wish, you can cancel heating before the set temperature is reached:  
**Access this function again and press STOP.**



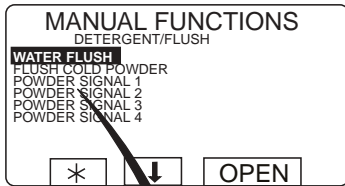

## Detergent signals and water flushing



3684

To access this function, see instructions in section "To select manual operation".



Use  and  to select the function you require.

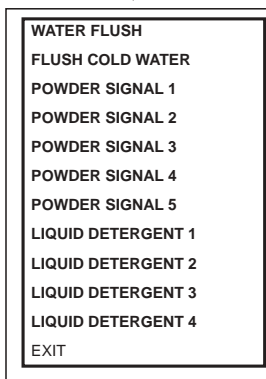

### *Detergent signals and water flushing*

#### **FLUSH WATER:**

This function uses water to clear detergent from the supply tubes of the detergent dispensing system.

#### **POWDER SIGNAL:**

This function will either: a) use water to dispense detergent from machine compartments, or: b) dispense detergent from an external system.



**Press OPEN.**



The function will be activated for as long as you press and hold this key. The function ceases as soon as you release the key.

When you have finished:

**Press  repeatedly to highlight "EXIT".**

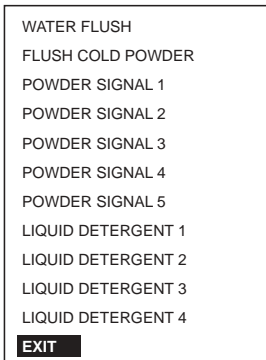

**Press SELECT.**

## Statistics

### To select Statistics



3589

If this menu is not currently displayed:

Press repeatedly.



Press to highlight "GO TO THE MENU".

RUN A WASH PROGRAM  
OPTIONS MENU

SELECT

Press SELECT.

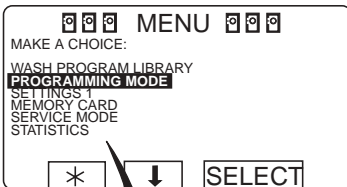

3691



Press five times...

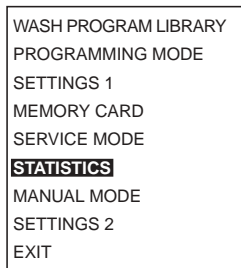

...to highlight "STATISTICS".

SELECT

Press SELECT.

STATISTICS		
TOTAL RUN TIME HOURS		0
TOTAL TRIP RUN TIME HOURS		0
HOURS SINCE LAST SERVICE		0
LAST 5 ERROR CODES		
08 NO HEATING	PROGRAM	HOURS
08 NO HEATING	991	0
08 NO HEATING	996	0
08 NO HEATING	993	0
08 NO HEATING	991	0
08 NO HEATING	991	0

3990



To display the next page of statistics:

Press .

STATISTICS			
PROGRAM	WASHES	PROGRAM	WASHES
2	4	10	0
12	0	52	0
78	0	123	0
991	35	992	3
993	1	994	0
995	0	996	0
997	0	998	0
999	0		

3958



To display the next page of statistics:

Press .

STATISTICS			
PROGRAM	WASHES	PROGRAM	WASHES
S 1	0	S 2	0
S 5	0	S 6	0
S 80	0	S 90	0
S 99	0	S 991	0
S 992	0	S 993	0
S 994	0	S 995	0
S 996	0	S 997	0
S 998	0	S 999	0

4040



If a memory card is in place in the PCU, the memory card program statistics will be displayed. An "S" before the program number shows that it is a memory card program.

When you want to cancel the display of statistics:

Press **EXIT**.

### The Statistics function

The Statistics function gives you access to the following information:

#### TOTAL RUN TIME HOURS:

Shows the total operating time for the machine since it was installed.

#### TOTAL TRIP RUN TIME HOURS:

This register records the total number of operating hours since it was last reset. It can, for example, be used to keep track of operating time since the last machine service. The procedure for resetting it is described in section "To reset "Total trip run time hours" to zero".

#### HOURS SINCE LAST SERVICE

This register shows the time elapsed since the last service. The register can also be used to generate a signal on the display to show when service is needed (see the section "Settings 1" in the service manual).

#### LAST 5 ERROR CODES:

This displays the most recent error codes, and tells which program was operating at the time and during which hour (according to the "total run time" record) the error code was flagged.

#### NO. OF TIMES EACH PROGRAM USED:

Displays statistics for PCU programs and for programs on any memory card currently in place in the PCU.

## Resetting statistic registers



3589

If this menu is not currently displayed:

Press repeatedly.



Press to highlight "GO TO THE MENU".

RUN A WASH PROGRAM  
**OPTIONS MENU**



Press **SELECT**.

### *Statistics registers which can be reset to zero*

The following registers in the statistics function can be cleared (reset to zero):

- Total trip run time hours.
- Hours since last service.
- No. of times each program used (PCU programs).
- No. of times each program used (programs on any memory card currently in the PCU).

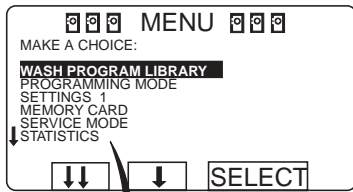

Press ..four times....

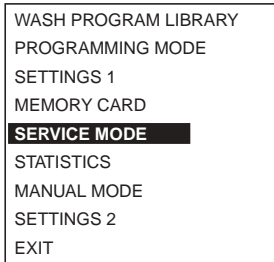

... to highlight "SERVICE PROGRAM".



Press SELECT

**The service program may only be used by authorised personnel, because most safety interlocks are disabled.**



Now you can choose either to clear/reset a register or to adjust the weighing equipment.

Press to highlight the option you want, then press SELECT.



If you want to exit:

Press repeatedly until EXIT is highlighted.

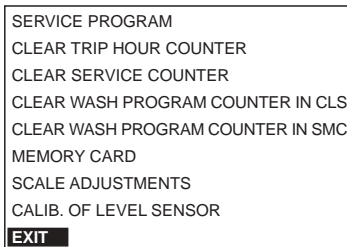

Press SELECT.

## Time counter, hours after last service

SERVICE MODE

MAKE A CHOICE:

SERVICE PROGRAM

CLEAR TRIP HOUR COUNTER

CLEAR SERVICE COUNTER

CLEAR WASH PROGRAM COUNTER IN CLS

CLEAR WASH PROGRAM COUNTER IN SMC

SCALE ADJUSTMENTS

CALIB. OF LEVEL SENSOR

EXIT

↑ ↓ SELECT

4041 A

Both counters can be reset in the same way.

Press  so that **CLEAR TRIP HOUR COUNTER OR CLEAR SERVICE COUNTER** will be marked.

Press **SELECT**.



SELECT

CLEAR COUNTER  
CLS

ARE YOU SURE ?

PRESS SELECT ELSE PRESS ANY OTHER KEY

\* \* SELECT

4043 A

First you have a chance to change your mind.

If you **do not** want to reset the register:

Press any key **other than SELECT**.

If you want to reset the register:  
Press **SELECT**.

SELECT

## Number of washes for program in timer or memory card

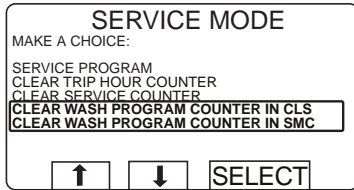

4044 A



You can reset program in both timer and the memory card (if inserted).

Press  so that **CLEAR WASH PROGRAM COUNTER IN CLS** or **CLEAR WASH PROGRAM COUNTER IN SMC** will be marked.



Press **SELECT**.

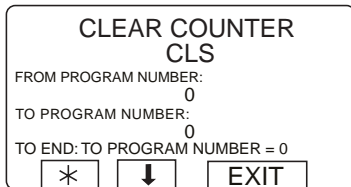

4045 A



Write from which program number you want to clear wash programs.



Press .

CLEAR COUNTER		
CLS		
FROM PROGRAM NUMBER:		
1		
TO PROGRAM NUMBER:		
0		
TO END: TO PROGRAM NUMBER = 0		
*	↓	EXIT

4046 A

1	2	3
4	5	6
7	8	9
0		

Enter digits corresponding to the program number (inclusive) up to which you wish to clear the total counter.

ERASE
-------

Press ERASE.

CLEAR COUNTER		
CLS		
ARE YOU SURE ?		
PRESS SELECT ELSE PRESS ANY OTHER KEY		
*	*	SELECT

4043 A

First you have the chance to change your mind.

If you **do not want to** reset the register:

**Press any key other than SELECT.**

If you do want to reset the register:

SELECT
--------

**Press SELECT.**

Now the totals of the program numbers you have specified will be cleared.

If you wish to change any numbers you have entered:

**Press ↑ if you want to change the first number entered. Enter the new number.**

If you change your mind:

**Press ↵.**



For machines with weighing equipment installed only!

## Scale

### Scale adjustments

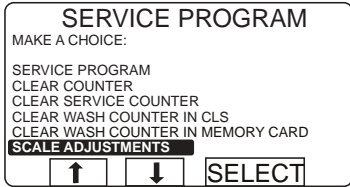

4777 A



Press  repeatedly until **SCALE ADJUSTMENTS** is highlighted.



Press **SELECT**.



When you have finished: Press  repeatedly until **EXIT** is highlighted.

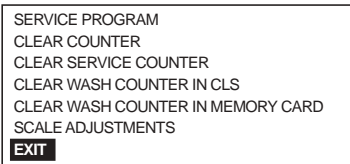

Press **SELECT**.

#### Scale adjustments

The following functions are accessed via the SCALE ADJUSTMENTS menu:

#### Reset scale to zero (see section "Reset scale to zero")

Used to make the weighing equipment display 0 when the machine has no load in it.

#### Reset tare to zero (see section "Reset tare to zero")

Used to clear a stored tare parameter.

#### Tare scale (see section "Tare scale")

Used to reset the weighing equipment so that a weight such as a container will not be included when calculating net weight.

#### Set tare to a certain value (see section "Set tare to a certain value")

Used to enter a value for the tare parameter, a weight in hectograms.

#### Read tare value (see section "Read tare value")

Used to check the value currently stored as the tare parameter.

#### Calibrate the scale (see section "Calibrate the scale")

This function is used only on installation of a new scale unit.

#### Zero calibration (see section "Zero calibration")

Used after installation of machine in order to put scale to 0 or when it is not possible to make scale to 0 with "Reset scale to zero".

#### Read version number (see section "Read version number")

This is where you find the version number of the weighing equipment.

If the weighing equipment is not connected, the error message "WEIGHING EQUIPMENT NOT CONNECTED" will be displayed. Connect the weighing equipment and try again. If necessary, see the section "Fault-finding, weighing equipment" in the machine manual.

For machines with weighing equipment installed only!

## Reset scale to zero

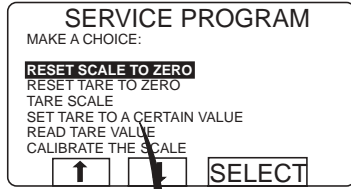

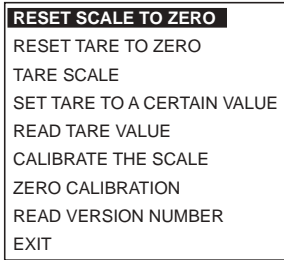

4778



Check that "RESET SCALE TO ZERO" is highlighted.

If it isn't...



Press  or  as required to highlight "RESET SCALE TO ZERO".



Press SELECT.

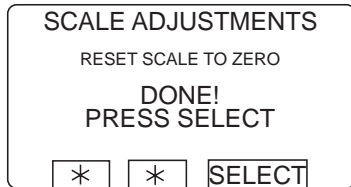

4779

This screen shows that the weighing equipment has been reset to zero.



Press SELECT.

### Reset scale to zero

"Reset weighing equipment" is used to make the weighing equipment display 0 when the machine has no load in it.

If your attempt to reset the weighing equipment fails at this point, you will see an error message equivalent to: "FAILED. PRESS SELECT" on the display. For troubleshooting, see the section "Fault-finding, weighing equipment" in the machine manual.

### Please note:

The machine must be unladen when you use this function, i.e. no water or wash load in the drum. Do not lean towards the machine.

### Please note:

After a power-cut, the weighing equipment will always display 0, no matter what the actual load in the drum. In this event you will have to use the "Reset scale to zero" function.

## Reset tare to zero

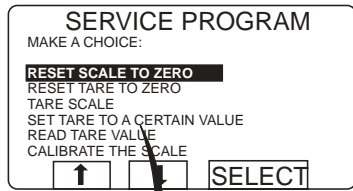

4780



Press  once to highlight "RESET TARE TO ZERO".

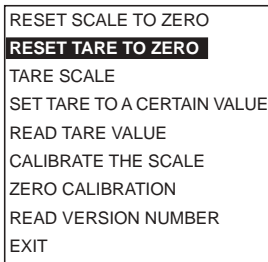

Press SELECT.

**Reset tare to zero**

If your attempt to clear the tare parameter fails at this point, you will see an error message equivalent to: "FAILED. PRESS SELECT" on the display. For troubleshooting, see the section "Fault-finding, weighing equipment" in the machine manual.

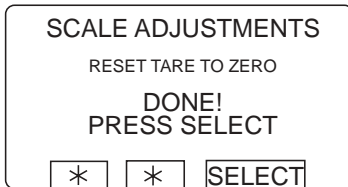

4781

This screen shows that the stored tare parameter has been cleared.



Press SELECT.

## Tare scale

4782

SERVICE PROGRAM  
MAKE A CHOICE:

**RESET SCALE TO ZERO**  
RESET TARE TO ZERO  
TARE SCALE  
SET TARE TO A CERTAIN VALUE  
READ TARE VALUE  
CALIBRATE THE SCALE

↑   ↓   SELECT



Press ↓ twice to highlight "TARE SCALE".

RESET SCALE TO ZERO  
RESET TARE TO ZERO  
**TARE SCALE**  
SET TARE TO A CERTAIN VALUE  
READ TARE VALUE  
CALIBRATE THE SCALE  
ZERO CALIBRATION  
READ VERSION NUMBER  
EXIT

SELECT

Press SELECT.

4783

SCALE ADJUSTMENTS  
TARE SCALE  
DONE!  
PRESS SELECT

\*   \*   SELECT

This screen shows that the weighing equipment has been tared successfully.

SELECT

Press SELECT.

**Tare scale**

This function involves first loading the drum with, for example, a container, then taring (resetting) the weighing equipment so that the weight of the container will not be included when calculating net weight.

If your attempt to tare the weighing equipment fails at this point, you will see an error message equivalent to: "FAILED. PRESS SELECT" on the display. For troubleshooting, see the section "Fault-finding, weighing equipment" in the machine manual.

## Set tare to a certain value

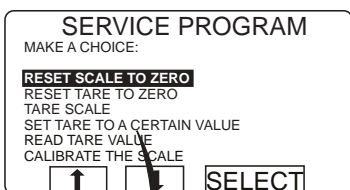

4784



Press  three times to highlight "SET TARE TO A CERTAIN VALUE"

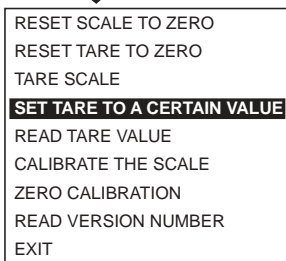

Press SELECT.

### Set tare to a certain value

This function lets you enter a value for the tare parameter, i.e. a weight value which the weighing equipment will disregard when showing a net weight on the display. The function will automatically clear any earlier tare value when you enter a new one.

If your value is not entered successfully at this point, you will see an error message equivalent to: "FAILED. PRESS SELECT" on the display. For troubleshooting, see the section "Fault-finding, weighing equipment" in the machine manual.

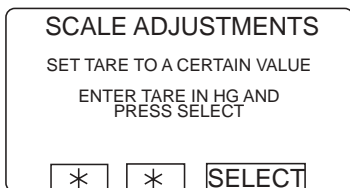

4785



Use the numeric keys to enter the tare you require, unit: hectograms; 1 hectogram = 0.1 kg).



Press SELECT.



4786



Press SELECT.

This screen shows that the parameter has been entered successfully.

## Read tare value

4787

**SERVICE PROGRAM**

MAKE A CHOICE:

**RESET SCALE TO ZERO**

RESET TARE TO ZERO

TARE SCALE

SET TARE TO A CERTAIN VALUE

READ TARE VALUE

CALIBRATE THE SCALE

↑   ↓   **SELECT**



Press four times to highlight "READ TARE VALUE".

RESET SCALE TO ZERO

RESET TARE TO ZERO

TARE SCALE

SET TARE TO A CERTAIN VALUE

**READ TARE VALUE**

CALIBRATE THE SCALE

ZERO CALIBRATION

READ VERSION NUMBER

EXIT

**SELECT**

Press **SELECT**.

4788

**SCALE ADJUSTMENTS**

READ TARE VALUE

10 HG

\*   \*   **SELECT**

**SELECT**

Press **SELECT**.

**Read tare value**

This function lets you check the value currently stored as the tare parameter.

## Calibrate the scale

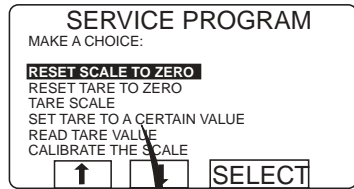

4789



Press five times to highlight "CALIBRATE THE SCALE".

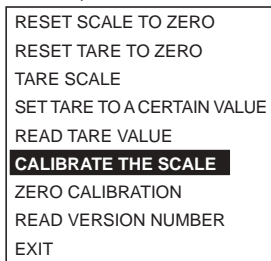

Press SELECT.

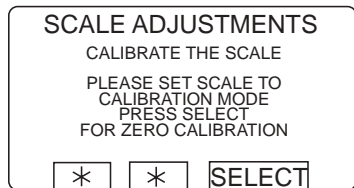

4790

Set the calibration switch to calibration mode.



Press SELECT.

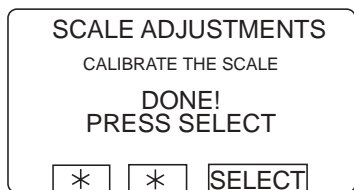

4791



Press SELECT.

**Please note:**

This function is used only on installation of a new scale unit.

**Calibrate the scale**

If this calibration has not succeeded you will see an error message equivalent to: "FAILED. PRESS SELECT" on the display. For troubleshooting, see the section "Fault-finding, weighing equipment" in the machine manual.

**Please note:**

The machine must be unladen at the start of calibration, i.e. no water or wash load in the drum.

**Calibration mode/normal mode**

To gain access to the calibration switch in the scale unit, the top panel has to be taken off. Remove the four screws on the scale unit cover. Then the calibration switch can be switched between normal mode "ON" and calibration mode "CAL".

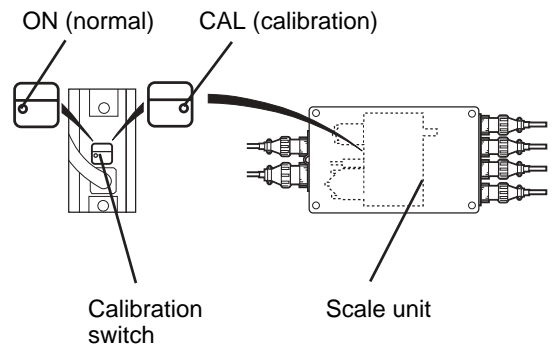

4758 A

For machines with weighing equipment installed only!

SCALE ADJUSTMENTS  
CALIBRATE THE SCALE  
FILL DRUM WITH CALIBRATION WEIGHT  
ENTER WEIGHT IN HG AND  
PRESS SELECT

\* \* SELECT

4792

1 2 3  
4 5 6  
7 8 9  
0

Put the calibration weight in the drum.

Use the numeric keys to enter the calibration weight in hg (1 hg = 0.1 kg).

SELECT

Press SELECT.

**Calibration weight**

A weight of between 20 kg and 40 kg should be used as a calibration weight.  
The higher the weight (within these limits), the better the weighing accuracy of the machine.

SCALE ADJUSTMENTS  
CALIBRATE THE SCALE  
DONE!  
PRESS SELECT

\* \* SELECT

4791

SELECT

Press SELECT.

SCALE ADJUSTMENTS  
CALIBRATE THE SCALE  
REMOVE WEIGHT AND PRESS SELECT

\* \* SELECT

4793

SELECT

Remove the calibration weight.

Press SELECT.

SCALE ADJUSTMENTS  
CALIBRATE THE SCALE  
PRESS SELECT FOR ZERO CALIBRATION

\* \* SELECT

4794

SELECT

If you want to use the "Calibrate zero" function now:

Press SELECT.



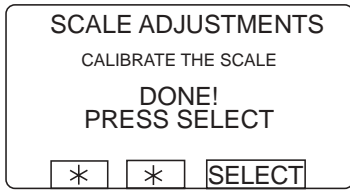

4791

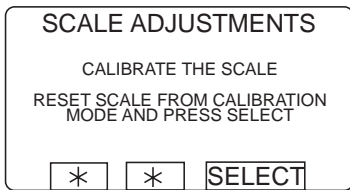
**SELECT****Press SELECT.**

4795

**SELECT****Press SELECT.**

**Restore the  
calibration switch to  
normal mode.**

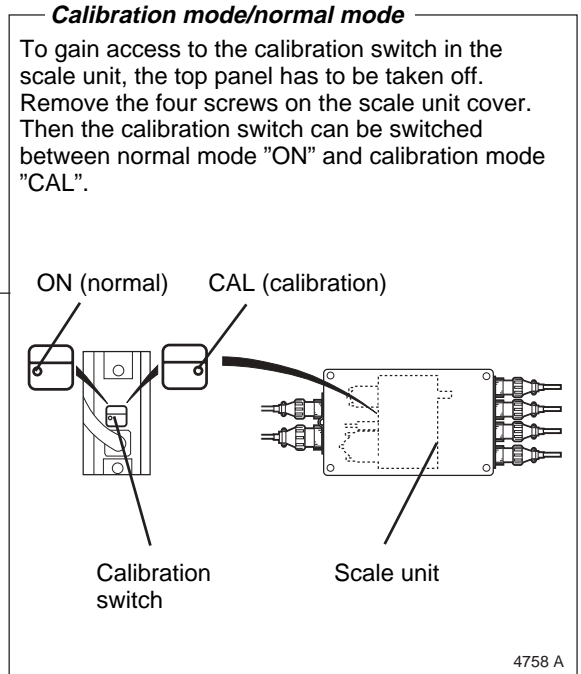

For machines with weighing equipment installed only!

## Zero calibration

4796

**SERVICE PROGRAM**

MAKE A CHOICE:

**RESET SCALE TO ZERO**

RESET TARE TO ZERO

TARE SCALE

SET TARE TO A CERTAIN VALUE

READ TARE VALUE

CALIBRATE THE SCALE



Press six times to highlight "ZERO CALIBRATION".

RESET SCALE TO ZERO

RESET TARE TO ZERO

TARE SCALE

SET TARE TO A CERTAIN VALUE

READ TARE VALUE

CALIBRATE THE SCALE

**ZERO CALIBRATION**

READ VERSION NUMBER

EXIT

Press **SELECT**.

4797

**SCALE ADJUSTMENTS**

ZERO CALIBRATION

PRESS SELECT FOR ZERO CALIBRATION

If you wish to calibrate zero for the weighing equipment:

Press **SELECT**.

4798

**SCALE ADJUSTMENTS**

ZERO CALIBRATION

**DONE!**

PRESS SELECT

This screen shows you have calibrated zero.

Press **SELECT**.

### Zero calibration

Used after installation of machine in order to put scale to 0 or when it is not possible to make scale to 0 with "Reset scale to zero".

If this calibration has not succeeded you will see an error message equivalent to: "FAILED. PRESS SELECT" on the display.

For troubleshooting, see the section "Fault-finding, weighing equipment" in the machine manual.

### Please note:

The machine must be unladen during this calibration, i.e. no water or wash load in the drum.

## Read version number

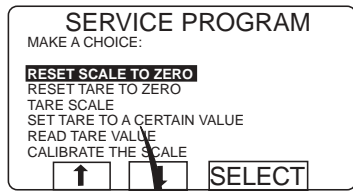

4799



Press  seven times to highlight "READ VERSION NUMBER".

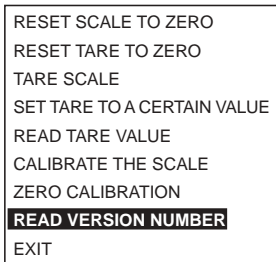

Press SELECT.

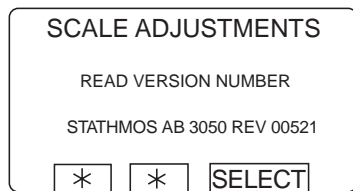

4800

The screen shows the version number.



Press SELECT.

**Read version number**

In the event of a fault in the weighing equipment (which cannot be put right with the aid of the section "Fault-finding, weighing equipment" in the machine manual), make a note of the version number accessed via this function before you contact the supplier's service department.

## Memory card

### General introduction

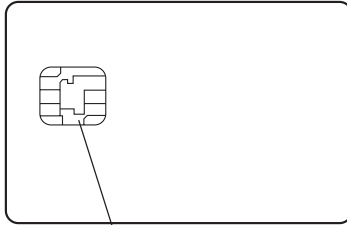

3605

Memory chip

A memory card is a plastic card, the size of a credit card, with an electronic memory chip inside it. This memory card is capable of storing 10 to 15 wash programs of normal size. If the programs are mostly small ones, more of them can be stored, whereas larger programs will reduce the number which can be held by the memory card. Memory card of this type, open card, can be used to:

- transfer wash programs from one machine to another
- run wash programs straight from the memory card
- transfer wash programs from a PC to a memory card and from a memory card to a PC (these procedures, and how to write a wash program on a PC, are described elsewhere)

A program stored on a memory card may be given restricted-use status. Locked card means that:

- The program cannot be deleted or copied to the program control unit of a washer extractor.
- You cannot alter the program or inspect the way it is written.
- To run the program you have to have the memory card and to insert it into the program control unit when the program is to be started.

### Open card

The content of the open card can be downloaded into a machine. The content in a machine can be uploaded to a card. The content can also be downloaded to several machines.

### Locked card

The content can not be changed and can not be downloaded to a machine. At operation, the card has to be inserted into the card reader. Program can not be uploaded to the card. Erasing the card is possible.

## To select the "Memory card" function

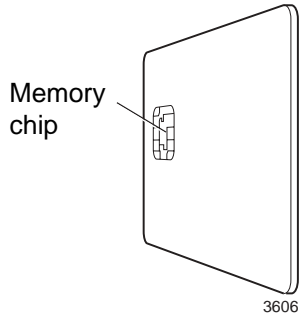

Turn the memory card so its memory chip is at the far end, and on the left of the card...

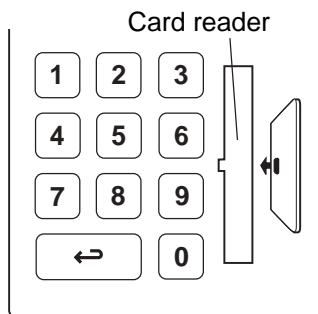

...then insert the memory card into the program control unit.



If this menu is not currently displayed:  
Press repeatedly.



Press to highlight "GO TO THE MENU".



Press SELECT.

# Memory card

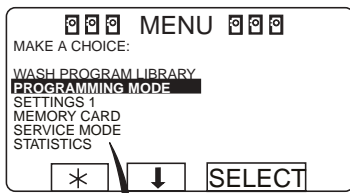

3596



Press ↓ three times...

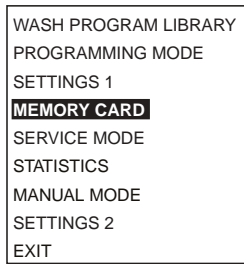

...to highlight "MEMORY CARD".



Press SELECT.

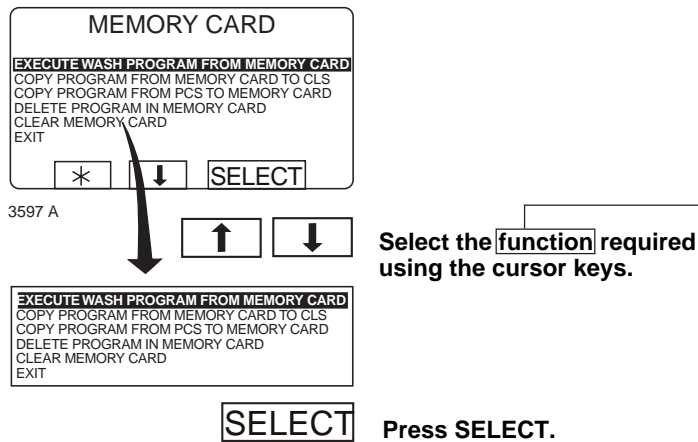

**"The "Memory card" functions**

**Run wash program straight from memory card (see section "To run a wash program straight from a memory card")**

A wash program can be run from the memory card, without first being copied to the washer extractor. The memory card may be removed from the card reader after the program has started.

Programs on memory cards may have "restricted-use" status, which means that they can only be run straight from the memory card, not copied or modified.

**Copy program from memory card to CLS (see section "To copy a program from a memory card to the machine's program control unit")**

One or more wash programs can be copied from the memory card to the memory chip in the machine's program control unit. Note that programs on the memory card with "restricted-use" status cannot be copied to the machine memory chip.

**Copy program from CLS to memory card (see section "To copy a program from the program control unit to a memory card")**

One or more wash programs can be copied from the memory chip in the machine's program control unit to the memory card. The memory card can hold 10 to 15 wash programs of normal size.

**Delete program on memory card (see section "To delete a program on a memory card")**

**Clear memory card (see section "To delete all programs on a memory card")**

# Memory card

## To run a wash program straight from a memory card

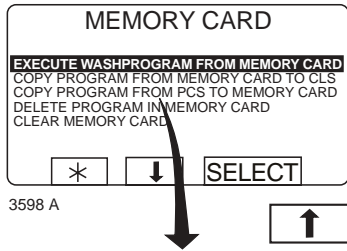

3598 A

To access this menu, follow the instructions in section "To select the "Memory card" function".

Highlight "EXECUTE WASH PROGRAM FROM MEMORY CARD" (press **↑** if necessary).

**SELECT**

Press SELECT.

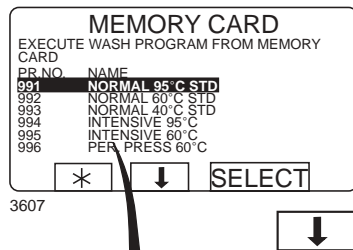

3607

If necessary, use **↓** to...

... highlight the wash program required.

**SELECT**

Press SELECT.

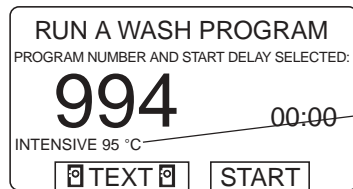

3608

Program name

**TEXT**

If you want to see the description of the program (where available):  
Press TEXT.

**START**

To start the program:  
Press START.  
Once the program has started, the memory card may be removed from the card reader.

### To run a program from the memory card

In broad terms, the program control unit has two different memories. One is a "program memory" where all its wash programs are stored, the other is an "operating memory", which is used to hold the program currently in use. The program control unit takes the instructions it needs to run the program from the operating memory.

When a wash program is started, the correct program is retrieved from the program memory and copied into the operating memory.

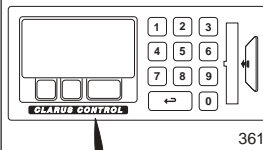

3617

#### Program memory program control unit

991	NORMAL 95°C STD
992	NORMAL 60°C STD
993	NORMAL 40°C STD
994	INTENSIVE 95°C
995	INTENSIVE 60°C
996	PERM. PRESS 60°C
997	PERM. PRESS 40°C
998	LOW EXTRACT 1 MIN
999	HIGH EXTRACT 5 MIN

1	MY OWN 40 °C
2	MY OWN 60 °C
3	MY OWN 90 °C
991	Start-up program
992	Level check
993	Weight check
994	Temperature check
995	Low extraction 500 rpm 1 minute
996	Low extraction 500 rpm 5 minutes
997	Extraction 775 rpm 2 minutes (15s 550)
998	Extraction 950 rpm 4 minutes (15s 550 + 15s 775)
999	High extraction 1100 rpm 5 minutes (15 + 15 + 20s 950)

#### Operating memory program control unit

997	PERM. PRESS 40°C
-----	------------------

Program currently being used

A parallel process takes place when a program is started from a memory card. In other words, the program is copied from the memory card into the operating memory, and the machine runs the program entirely from the set of instructions in the operating memory.

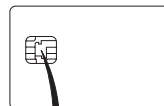

#### Program memory card

1	MY OWN 40 °C
2	MY OWN 60 °C
3	MY OWN 90 °C
4	MY OWN WOOL 30 °C
5	MY OWN INTENSIVE

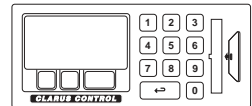

3618

#### Program memory program control unit

991	NORMAL 95°C STD
992	NORMAL 60°C STD
993	NORMAL 40°C STD
994	INTENSIVE 95°
995	INTENSIVE 60°C
996	PERM.PRESS 60°C
997	PERM.PRESS 40°C
998	LOW EXTRACT 1 MIN
999	HIGH EXTRACT 5 MIN

#### Operating memory program control unit

4	MY OWN WOOL 30 °C
---	-------------------

That is why you may remove the memory card from the card reader once the program has started. Once the program has ended it is erased from the operating memory.



## To copy a program from a memory card to the machine's program control unit

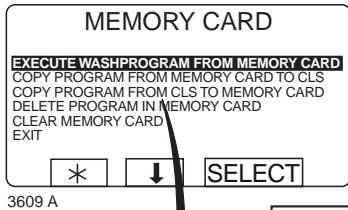

3609 A

To access this menu, follow the instructions in section "To select the "Memory card" function".

**Note that** restricted-use programs on a memory card cannot be copied.

**Highlight "COPY PROGRAM FROM MEMORY CARD TO CLS"** (press or if necessary).

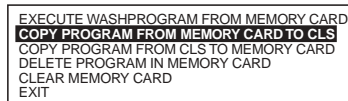

**SELECT**

Press SELECT.

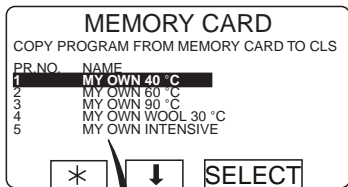

3610 A

If necessary, use to...

... highlight the wash program required.

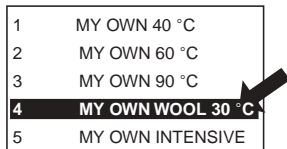

**SELECT**

Press SELECT.

### What is a restricted-use program?

A wash program which has been created on a PC can be made a "restricted-use" program. This means that:

- The program cannot be deleted or copied to the program memory of a washer extractor.
- You cannot modify the program or examine its structure.
- To run the program you must have access to the memory card, and insert it into the card reader when the program is to be started.

### What happens when a program is copied?

Both the memory card and the program control unit have memory chips capable of storing wash programs. The chip on the card can hold about 10 to 15 programs of normal size, while the chip in the program control unit has a capacity of several hundred programs.

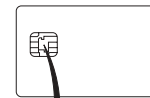

Program memory card

1	MY OWN 40 °C
2	MY OWN 60 °C
3	MY OWN 90 °C
4	MY OWN WOOL 30 °C
5	MY OWN INTENSIVE

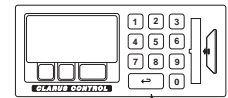

3614

Program memory program control unit

991	NORMAL 95°C STD
992	NORMAL 60°C STD
993	NORMAL 40°C STD
994	INTENSIVE 95°
995	INTENSIVE 60°C
996	PERM.PRESS 60°C
997	PERM.PRESS 40°C
998	LOW EXTRACT 1 MIN
999	HIGH EXTRACT 5 MIN

When a program is copied from a memory card to the machine's program control unit, it is copied, not moved (not deleted from the card). A copy is transferred from the chip on the memory card to the storage chip of the machine program control unit.

Program memory card

1	MY OWN 40 °C
2	MY OWN 60 °C
3	MY OWN 90 °C
4	MY OWN WOOL 30 °C
5	MY OWN INTENSIVE

Program memory program control unit

4	MY OWN WOOL 30 °C
991	NORMAL 95°C STD
992	NORMAL 60°C STD
993	NORMAL 40°C STD
994	INTENSIVE 95°
995	INTENSIVE 60°C
996	PERM.PRESS 60°C
997	PERM.PRESS 40°C
998	LOW EXTRACT 1 MIN
999	HIGH EXTRACT 5 MIN

3615

The program remains on the memory card, but another copy of it has now been stored in the program control unit.

Program memory card

1	MY OWN 40 °C
2	MY OWN 60 °C
3	MY OWN 90 °C
4	MY OWN WOOL 30 °C
5	MY OWN INTENSIVE

Program memory program control unit

4	MY OWN WOOL 30 °C
991	NORMAL 95°C STD
992	NORMAL 60°C STD
993	NORMAL 40°C STD
994	INTENSIVE 95°
995	INTENSIVE 60°C
996	PERM.PRESS 60°C
997	PERM.PRESS 40°C
998	LOW EXTRACT 1 MIN
999	HIGH EXTRACT 5 MIN

3616

# Memory card

**MEMORY CARD**  
 COPY PROGRAM FROM MEMORY CARD TO CLS  
 NOW YOU CAN CHANGE NUMBER. 123  
 JUST PRESS SELECT IF NUMBER IS OK

\* ↓ SELECT

3611 A

1 2 3  
 4 5 6  
 7 8 9  
 0

SELECT

### Choose 1 or 2:

- 1 If you want to give the program a different program number (from the one it had on the memory card):

**Use the numeric keys to enter the new program number, then press SELECT.**

- 2 If the existing number is suitable:

**Press SELECT.**

**MEMORY CARD**  
 COPY PROGRAM FROM MEMORY CARD TO CLS  
 NOW YOU CAN CHANGE NUMBER 00  
 PROG. NUMBER EXIST! OVERWRITE?  
 PRESS SELECT OR ANY OTHER KEY

\* ↓ SELECT

4114 A

1 2 3  
 4 5 6  
 7 8 9  
 0

SELECT

If the number you have chosen is already used:

- 1 Select another number.

**Enter the new number and press SELECT.**

- 2 Erase the old program number.

**Press SELECT.**

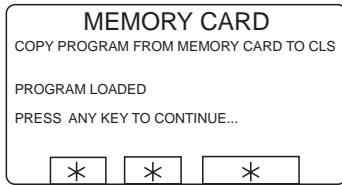

3612 A

After the program has been copied (it takes only a few seconds) the menu will look like this:

If you want to copy more programs:

**Press any key to continue.**

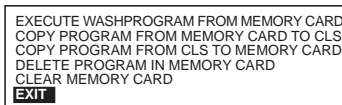

4210 A

When you have finished:

**Press**  **repeatedly to highlight "EXIT".**

**SELECT**

**Press SELECT.**

# Memory card

## To copy a program from the program control unit to a memory card

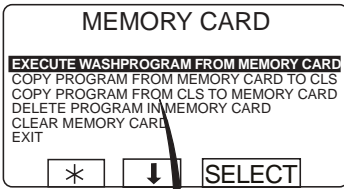

3619 A



Highlight "COPY PROGRAM FROM CLS TO MEMORY CARD" (press or if necessary).

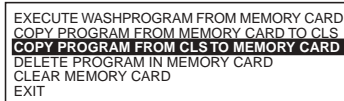

Press SELECT.

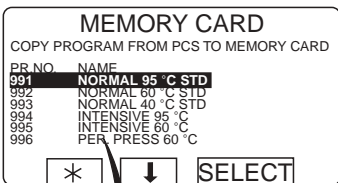

3620



If necessary, use to...

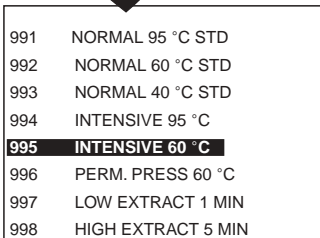

... highlight the wash program required.



Press SELECT.

### What happens when a program is copied?

Both the memory card and the program control unit have memory chips capable of storing wash programs. The chip on the memory card can hold about 10 to 15 programs of normal size, while the chip in the program control unit has a capacity of several hundred programs.

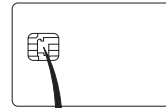

Program memory card

1	MY OWN 40 °C
2	MY OWN 60 °C
3	MY OWN 90 °C
4	MY OWN WOOL 30 °C
5	MY OWN INTENSIVE

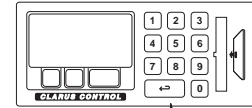

Program memory program control unit

991	NORMAL 95°C STD
992	NORMAL 60°C STD
993	NORMAL 40°C STD
994	INTENSIVE 95°
995	INTENSIVE 60°C
996	PERM.PRESS 60°C
997	PERM.PRESS 40°C
998	LOW EXTRACT 1 MIN
999	HIGH EXTRACT 5 MIN

When a program is copied from the machine's program control unit to a memory card, it is copied, not moved (not deleted from the machine). A copy is transferred from the storage chip of the machine program control unit to the chip on the card.

Program memory card

1	MY OWN 40 °C
2	MY OWN 60 °C
3	MY OWN 90 °C
4	MY OWN WOOL 30 °C
5	MY OWN INTENSIVE
992	NORMAL 60 °C STD

Program memory program control unit

991	NORMAL 95°C STD
992	NORMAL 60°C STD
993	NORMAL 40°C STD
994	INTENSIVE 95°
995	INTENSIVE 60°C
996	PERM.PRESS 60°C
997	PERM.PRESS 40°C
998	LOW EXTRACT 1 MIN
999	LOW EXTRACT 5 MIN

The program remains in the program control unit, but another copy of it has now been stored on the card.

Program memory card

1	MY OWN 40 °C
2	MY OWN 60 °C
3	MY OWN 90 °C
4	MY OWN WOOL 30 °C
5	MY OWN INTENSIVE
992	NORMAL 60 °C STD

Program memory program control unit

991	NORMAL 95°C STD
992	NORMAL 60°C STD
993	NORMAL 40°C STD
994	INTENSIVE 95°
995	INTENSIVE 60°C
996	PERM.PRESS 60°C
997	PERM.PRESS 40°C
998	LOW EXTRACT 1 MIN
999	LOW EXTRACT 5 MIN

**MEMORY CARD**  
COPY PROGRAM FROM CLS TO MEMORY CARD  
NOW YOU CAN CHANGE NUMBER. 998  
JUST PRESS SELECT IF NUMBER IS OK

\* ↓ SELECT

3623 A

1 2 3  
4 5 6  
7 8 9  
0

SELECT

**Choose 1 or 2:**

**1** If you want to give the program a different program number (from the one it had on the machine):

**Use the numeric keys to enter the new program number, then press SELECT.**

**2** If the existing number is suitable:

**Press SELECT.**

**MEMORY CARD**  
COPY PROGRAM FROM MEMORY CARD TO CLS  
NOW YOU CAN CHANGE NUMBER 00  
PROG. NUMBER EXIST! OVERWRITE?  
PRESS SELECT OR ANY OTHER KEY

\* ↓ SELECT

4114 A

1 2 3  
4 5 6  
7 8 9  
0

SELECT

If the number you have chosen is already used:

**1** Select another number.

**Enter the new number and press SELECT.**

**2** Erase the old program number.

**Press SELECT.**

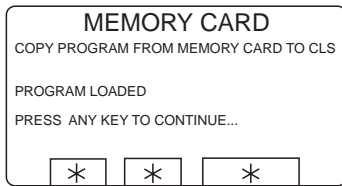

3612 A

After the program has been copied (it takes only a few seconds) the menu will look like this:

If you want to copy more programs:

**Press any key to continue.**

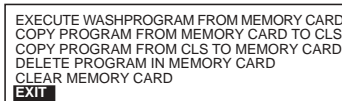

4210 A

When you have finished:

Press  repeatedly to highlight "EXIT".

**SELECT**

Press SELECT.

## To delete a program on a memory card

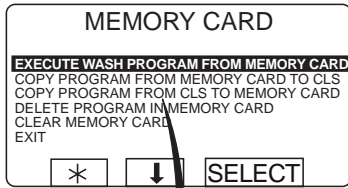

3625 A

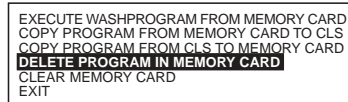

To access this menu, follow the instructions in section "To select the "Memory card" function

**Note that** restricted-use programs on a memory card cannot be deleted.

**Highlight "DELETE PROGRAM IN MEMORY CARD"** (press or if necessary).

### What is a restricted-use program?

A wash program which has been created on a PC can be made a "restricted-use" program. This means that:

- The program cannot be deleted or copied to the program memory of a washer extractor.
- You cannot modify the program or examine its structure.
- To run the program you must have access to the memory card, and insert it into the card reader when the program is to be started.

Press SELECT.

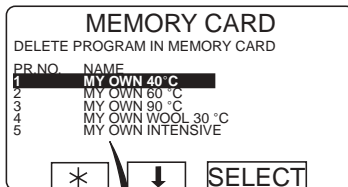

3626



If necessary, use to...

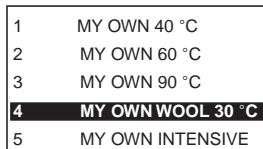

.... highlight the wash program required.



Press SELECT.

The program will now be deleted from the memory card. This takes between 5 and 15 seconds.

If you want to delete more programs:

**Continue in the same way as described above.**

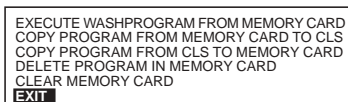

4210 A



When you have finished:

Press repeatedly to highlight "EXIT".

Press SELECT.

## To delete all programs on a memory card

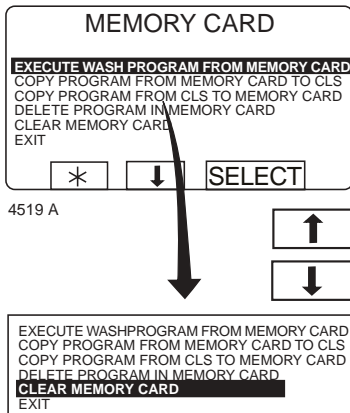

SELECT

Press SELECT.

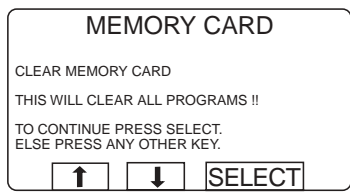

SELECT

If you change your mind and do not want to delete the entire memory card:

**Press any key other than SELECT.**

If you want to delete all programs on the memory card (with the exception of any restricted-use programs):

**Press SELECT.**

### *What is a restricted-use program?*

A wash program which has been created on a PC can be made a "restricted-use" program. This means that:

- The program cannot be deleted or copied to the program memory of a washer extractor.
- You cannot modify the program or examine its structure.
- To run the program you must have access to the memory card, and insert it into the card reader when the program is to be started.

**Note that** restricted-use programs on a memory card cannot be copied or deleted.

**Highlight "CLEAR MEMORY CARD" (press ↓ or ↑ if necessary).**



## Maintenance

### Daily

- Clean the door seal and remove detergent residue.
- Check that the door does not leak.
- Clean the detergent compartment and wipe down the machine with a damp cloth.
- Check that the drain valve does not leak.
- Start the machine and check that the door remains locked while the machine is operating. Fast forward the machine to the stop position and check that the door cannot be opened until the program is completed.

### Machine with scale

- Check that panels are mounted.
- Check that no foreign objects are placed on the machine.
- Check that inlet and drain hoses are hanging freely.
- Check 0-weight.

### Every month

- Check that valves, hoses and connections do not leak.
- Remove any textile lint from the drain opening, joints in drain pipes etc.
- Check the door locking relay.
  - Select program 991 ("Start-up program"). When level is reached, press the emergency stop button. The door lock relay shall open when the water level has drained close to the bottom surface of the inner drum.  
Reset the emergency stop button and switch power off and on to reset the error message. **Note**, the door lock relay must not open immediately.

### Calibration of level control system

The level control system can be individually and manually calibrated. The calibration starts at the level at the bottom of the inner drum. The calibration can be made up to 250 mm from the bottom of the inner drum.

A ruler is supplied with the machine where the water level above the inner drum can be read.

1

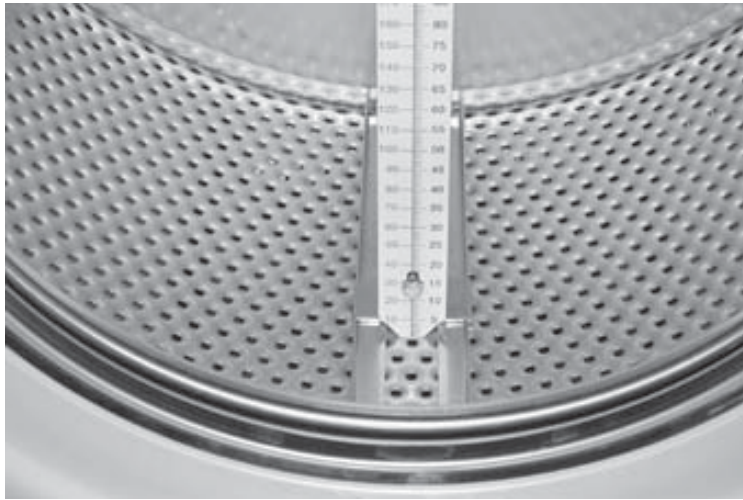

CLS 7.jpg

Fig.

1

- Place the ruler on the bottom of the inner drum, equally between two lifters and front and rear gables. Rotate the drum so that the ruler is totally vertical and assure that the three pins of the ruler fit in the holes of the inner drum.
- Push the scale to the bottom of the drum and tighten the nuts.

2

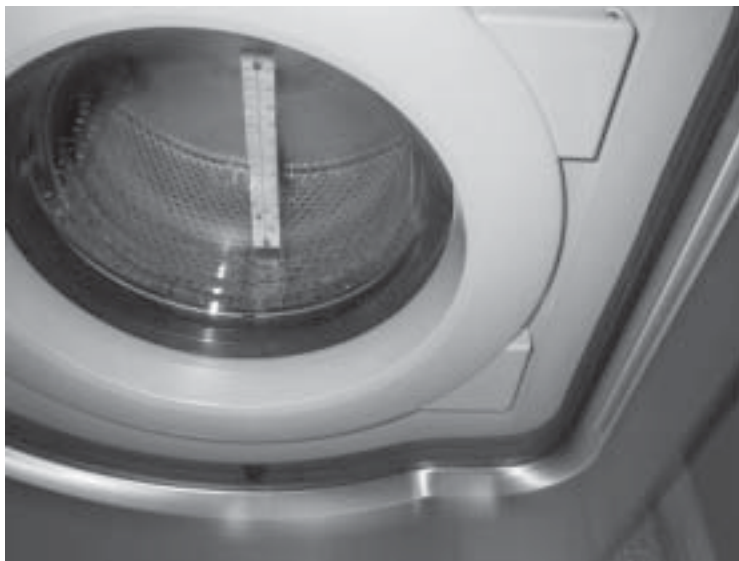

IMG 0012.jpg

Fig.

2

- Close the door.

Fig. 3

- The ruler has two different scales, one in mm and one in RU units (exactly 2 mm/RU units).  
The calibration shall be made in at least five level steps, and the first step when the water just enters the inner drum. More calibration steps can be made if requested.
  - Go down to "Options menu"
  - Press "Select"
  - Go down to "Service mode"
  - Press "Select".

3

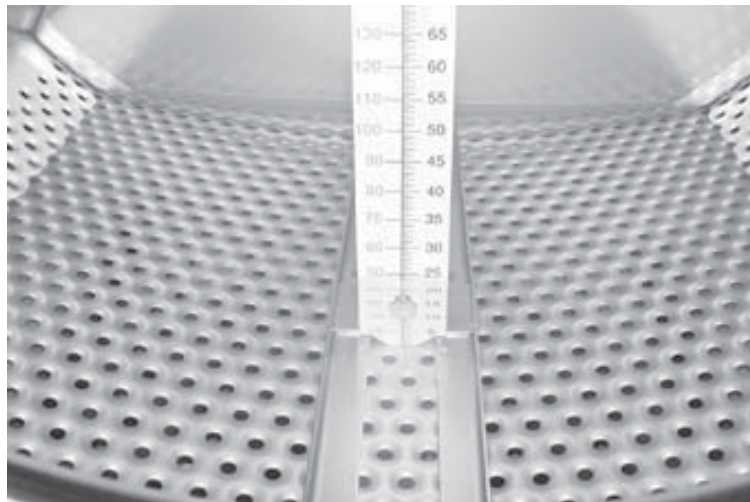

CLS 4.jpg

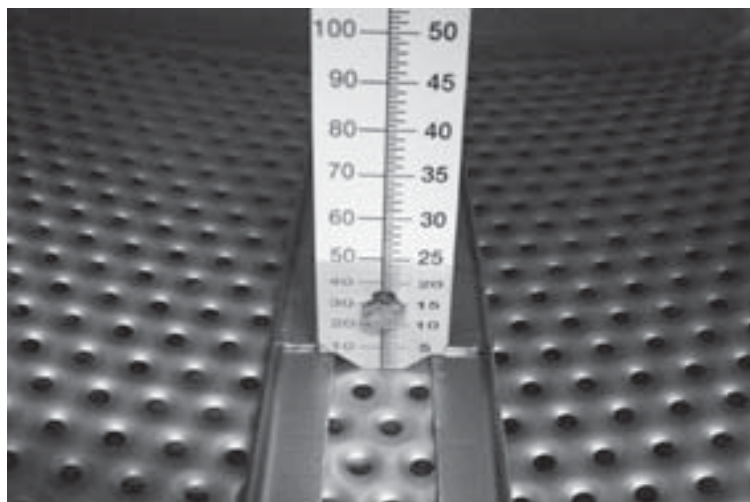

CLS 6.jpg

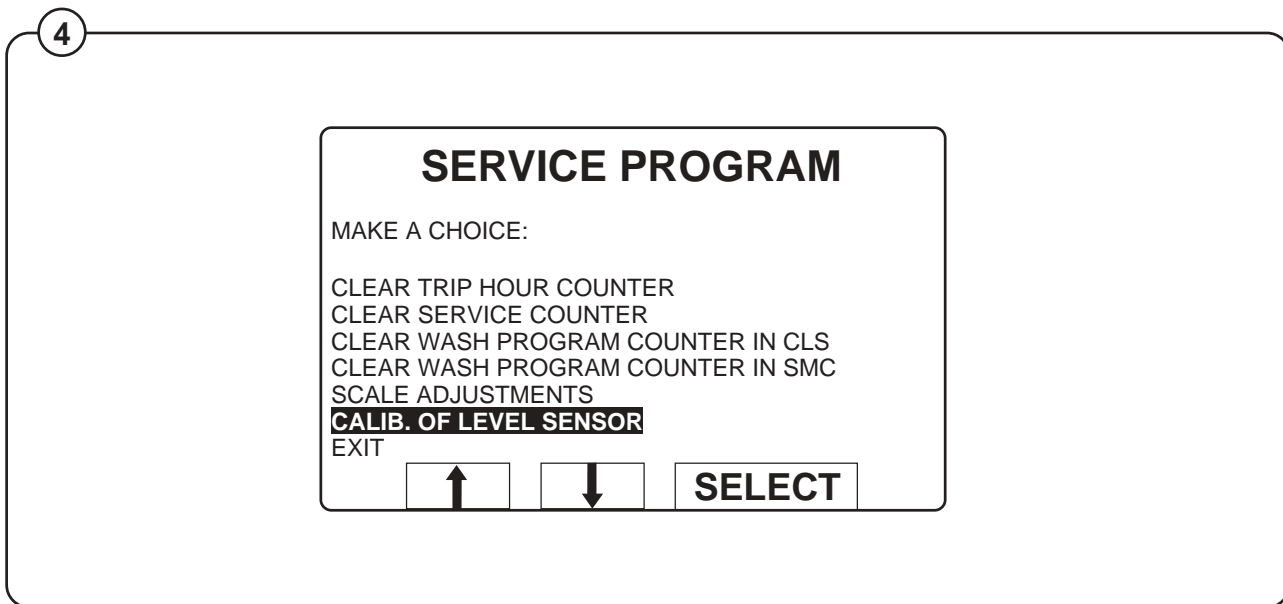
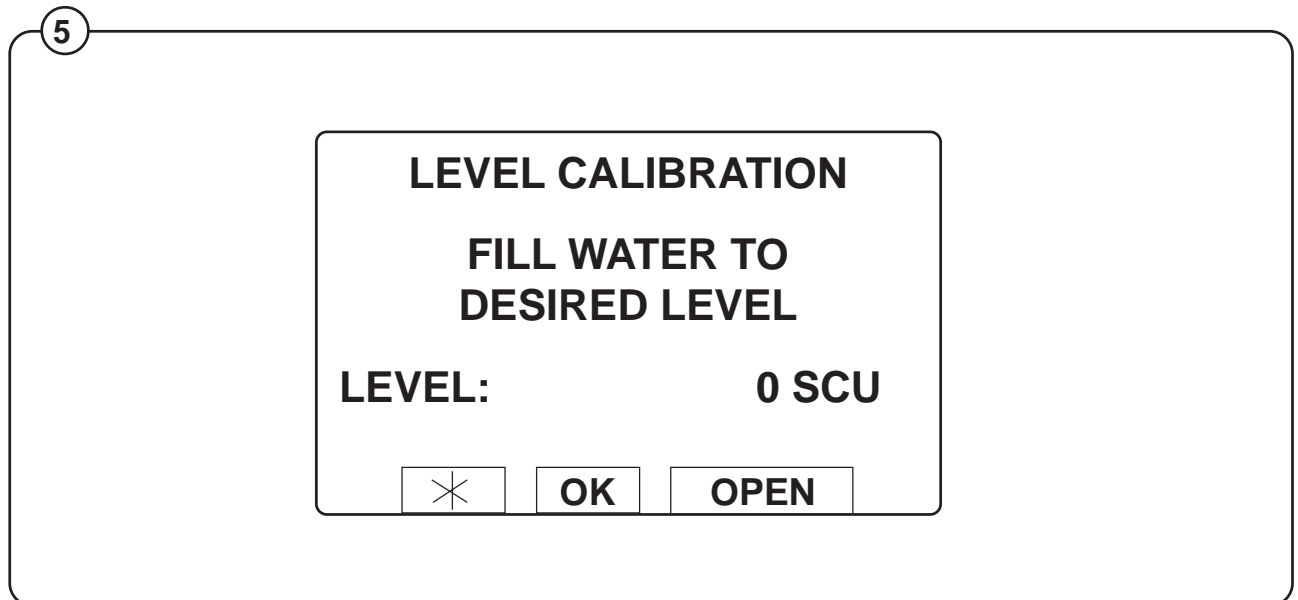

Fig. 4 • "Service Mode" menu is now shown on the display.

4

- Close the door.
- Go down to "Calibration of level sensor"
- Press "Select"



- Fig. 5
- Press "Open" to fill water until the water reaches the bottom of the inner drum where the ruler is placed.
  - Press "OK"
  - Enter the value read on the ruler in RU units (The first setting is 0=level in drum).
  - Press "OK"
  - Press "Open" to fill more water.
  - Press "OK"
  - Enter the value read on the ruler in RU units. (If wrong value is entered, press "CLR". Enter new value.
  - Press "OK"
  - Enter another three values so that it will be five different totally.
  - When all values have been entered, press "Save"

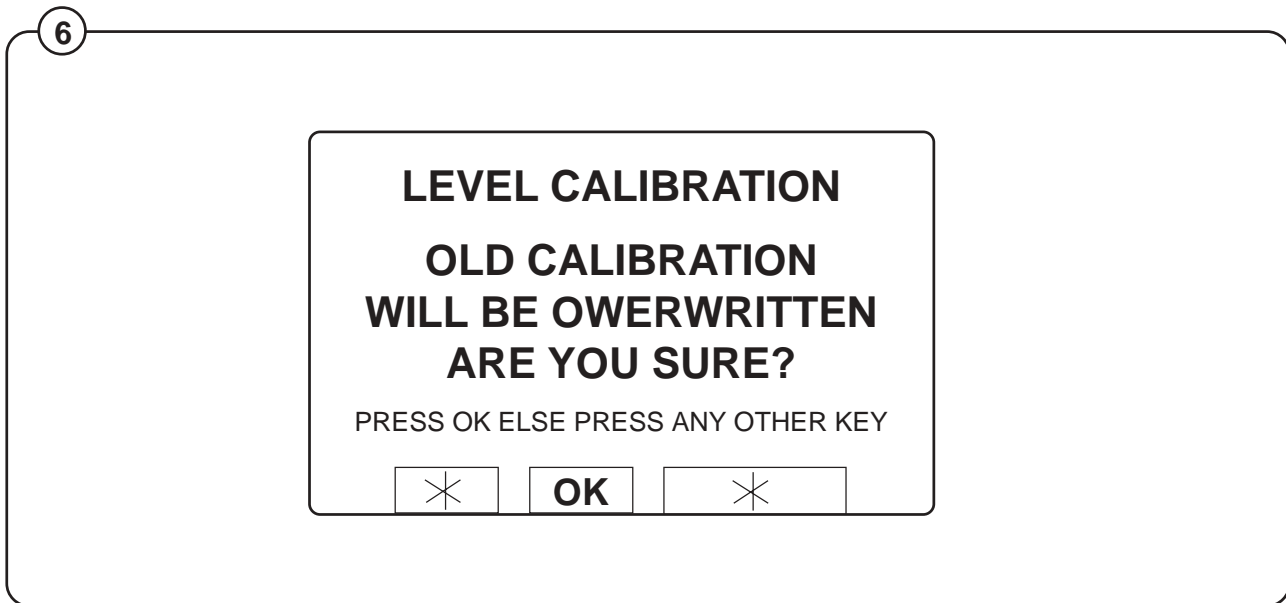

- Fig. 6
- Press "OK"
  - Go down to "Exit"
  - Press "Select"

### Zero adjustment of the scale (weight function)

The scale itself is calibrated from factory and no adjustment should be necessary unless some scale parts need to be changed. However a zero adjustment needs to be done as the total weight of the machine needs to be programmed into the scale.

Be sure that the water and drain hoses are in place and properly mounted. Be sure that all panels are mounted and the cover over the power connection is placed on top of the machine.

- Enter the "service mode" as in level calibration.
- In "service mode" go to "scale adjustment"
- Press "Select"
- Go down to "Zero calibration"
- Press "Select"
- Press "Select" (Be sure that there are no extra weight on the machine. And don't lean on the machine).
- When display text "Reset scale from calibration..." appears, press "Select"
- Go down to "Exit"
- Press "Select"
- Go back to main menu.

The zero adjustment is now done and the weight of the empty machine should now be read on the display as 0.0 kg (a difference of  $\pm 0.1$  kg is allowed). If another value is shown in the display, the zero adjustment has to be done again from the start.

# Calibration of the reference machines

## Wascator FOM 71 CLS

---

78

### Checklist for calibration of Wascator FOM 71 CLS



**Some of the checkpoints results in exposure to dangerous line voltages or rotating parts and must be carried out only by authorized personnel.**

This approval inspection shall be performed at least once a year. All measurement equipment shall be of laboratory type (see list below) with identification labels and checked not more than 12 months prior the testing.

For calibration procedures see list below and the manual following the machine. Follow the instructions and report all values in attached xxxx enclosed to this instruction.

A reference machine passing all the calibration checks will conform with the specification given in IEC 456.

#### Measurement equipment needed:

- Water level
- Multimeter
- Speedo meter, digital tachometer
- Temperature instrument
- Time watch
- Weights



### Checks to be made

#### 1. Heating element power **\*\*\*WARNING\*\*\***

Remove the front panel and measure the cold resistance of the heating elements. The elements shall be at ambient temperature and the machine should not have been run for at least 5 hours.

Resistance at 20° shall be:

Rated voltage according to data label attached on machine	Resistance
400/230 volts	28.5 - 29.7 ohms
415/240 volts	30.9 - 32.2 ohms

#### 2. Visual heating element inspection **\*\*\*WARNING\*\*\***

Remove one of the heating elements and visually inspect for and build up of lint, limestone, etc. which can cause reduced heater efficiency.

#### 3. Line voltage **\*\*\*WARNING\*\*\***

Measure the rated voltage between L1 - L2 - L3 on the incoming mains to the machine.

#### 4. Leveling of the machine

The machine must be installed on a flat horizontal surface. Check that the top of the machine is horizontal. Measure with a water-level. Deviation from horizontal at any top panel corner must not exceed 5 mm.

#### 5. Drain installation

Check drain installation, minimum drain diameter 50 mm. A drain with a 150 mm free vertical flow is recommended but not compulsory.

#### 6. Water supply

Check of water supply pressure and supply filling rate. Supply pressure shall be between 200 - 600 kPa (2-6 bar). Measure the supply time using the "weight check" program:

FOM 71 CLS                      Program 993 (18 kgs)

The machines shall be without load.

Supply time to 18 kgs shall be 60 - 75 seconds.

# Calibration of the reference machines

## Wascator FOM 71 CLS

---

80

### 7. Leakage at drain and inlet valve

Check for leakage at drain and inlet valves.

Run weight check program (see 6).

Weight 18 kgs. Pause the machine for 15 minutes.

After 15 minutes the weight shall not be changed.

Reading tolerances  $\pm 1$  mm.

### 8. Calibration of the internal level scale

Calibrate the level control according to Operating manual.

### 9. Water level

Water level adjustments and checks.

Use level check programs. The machine shall be without load and not rotating.

Run the level check program 992. The program fills repeatedly to 100, 130, 160 and 200 mm. Read water level at each stop on the internal ruler. Max. deviation  $\pm 5$  mm.

### 10. Weight check

Zero calibrate the machine according to Operating manual. The machine shall be at stand still. Place a calibrated weight of 10 kgs on the top of the machine. Read the scale output. Repeat with an additional 10 kgs. Read the output. Displayed weight shall be within  $\pm 0.1$  kg from the calibrated weights.

### 11. Drain time

Use level check program 992. Fill to 160 mm. Drain the water. Measure the drain time until full flow is reduced. Max. allowable time 30 seconds.

**12. Temperature control**

Use temperature control program 994. Put a temperature probe through the upper door gasket into the bath or use the laboratory temperature measurement system (must be calibrated separately in advance). Read the temperatures at 25°, 40°, 60° and 80° on the machine display and on the measurement instruments.

Max. deviation  $\pm 1^{\circ}\text{C}$ .

**13. Drum speed at wash. \*\*\*WARNING\*\*\***

Remove the back panel. Run program 991.

The wash speed shall be measured with a speedo meter (reflector type).

The reflector shall be placed on the big pulley. Wash speed shall be measured at nominal voltage and with a load of 5 kg of cotton as load.

Speed variation allowable in both directions:  $52 \pm 1$  RPM.

**14. Extraction speed \*\*\*WARNING\*\*\***

Proceed as in 13, but rapid advance to last drain after wetting the load and measure the extraction speed with a well balanced load of wet cotton (dry weight 5 kg) after reaching set speed 500 rpm.

Extraction speed shall be within  $500 \pm 20$  RPM.

**15. Recording of complete program (not compulsory)**

Record using the laboratory recording equipment the complete IEC 60° cotton program. For best calibration accuracy use no load.

Parameters to be recorded as a function of time:

Temperature  
Amount of water  
Speed

**Open door during wash cycle**

It is possible to open the door during a wash cycle in order to take out test samples.

But to be able to do so some criteria have to be fulfilled.

- The water level in the machine may not exceed 38 RU when the door is opened.
- The water temp may not exceed 60°C.

Two different pauses are approved for door opening during wash cycle.

- Programmed pause – the pause is programmed in the wash cycle.
- Select "PAUSE" by clicking down in the menu.



# CALIBRATION PROTOCOL

Wascator FOM 71CLS

Document number: ..... Page: 1(3)

Machine location: .....

Calibration made by: .....

Date: ..... Previous calibration date: .....

Signature: .....

## Machine data:

Wascator FOM 71CLS ....

Type .....

Ser. No. .... / .....

Voltage .....V.....Hz

## Measurement equipment:

.....

.....

.....

.....

## Instructions:

Instructions how to calibrate the Wascator FOM 71CLS are given in document: *Calibration of reference Wascator FOM 71CLS*. All instruments and measurements devices needed for the calibration shall confirm with instructions given in above document.

## Report summary:

**1. Heating element power**

230V: 28.5-29.7, 240V: 30.9-32.2 ohm

**2. Visual heating element inspection.****3. Line voltage.****4. Levelling of the machine.****5. Drain installation.****6. Water supply.****7. Leakage at drain and inlet valve.****8. Calibration of water level scale.**

	Mandatory	Measured	After adjust
R1 ohm			
R2 ohm			
R3 ohm			
Visual	OK		
L1-L2			
L1-L3			
L2-L3			
lf-lr	< 5 mm		
rf-rr	< 5 mm		
lf-rf	< 5 mm		
lr-rr	< 5 mm		
d (mm)	> 50 mm		
P (bar)	2-6 bar		
Filltime	60-75 sec		
Leakage	0 ± 1 mm		
Level	0-200 mm		







# Washer extractors, Tumble dryers, Hydro extractors

**Types:** W.55H., W3..., WN3..., W4.H., EXSM.X., H1..., N1130..., N1190..., N2..., N3..., N4..., N5...

**Product standards:** EN 60335-2-4, -7, -11

**EMF standards:** EN 50366:2003 + A1

**EMC standards:** EN 61000-6-1 (2001) W.55H., W3..., W4.H., N1130, N1190, N2..., N3...  
EN 61000-6-3 (2001) W.55H., W3..., WN3..., W4.H., EXSM.X., N1130, N1190, N2..., N3...  
A11 (2003) WN3..., N5...  
EN 61000-3-11 (2001) EXSM.X.  
EN 61000-6-2 (2005) WN3..., N4..., N5...  
EN 61000-6-3 (2007) N4...

## Försäkran om överensstämmelse

Vi, Electrolux Laundry Systems Sweden AB  
SE-341 80 Ljungby, Sverige

försäkrar under eget ansvar att denna produkt, med typbeteckning och enl. ovan, är tillverkad i överensstämmelse med följande direktiv:

- LVD Directive 2006/95/EC
- EMC Directive 2004/108/EC
- GAS Directive 2009/142/EC (gäller endast N<sup>\*\*\*\*\*</sup> och WN3...)
- CE Marking Directive 93/68/EEC
- RoHS Directive 2002/95/EC
- WEEE Directive 2002/96/EC
- MD Directive 2006/42/EC

## CE Declaration of conformity

We, Electrolux Laundry Systems Sweden AB  
SE-341 80 Ljungby, Sweden

declare under our sole responsibility that the product of the type stated above is manufactured in conformity with the following EU directives:

- LVD Directive 2006/95/EC
- EMC Directive 2004/108/EC
- GAS Directive 2009/142/EC (N<sup>\*\*\*\*\*</sup>... and WN3... only)
- CE Marking Directive 93/68/EEC
- RoHS Directive 2002/95/EC
- WEEE Directive 2002/96/EC
- MD Directive 2006/42/EC

## EG-Konformitätserklärung

Wir, die, Electrolux Laundry Systems Sweden AB  
SE-341 80 Ljungby, Schweden

erklären hiermit in alleiniger Verantwortung, daß das Produkt mit der oben genannten Typenbezeichnung mit folgenden EU-Richtlinien übereinstimmt:

- LVD Directive 2006/95/EC
- EMC Directive 2004/108/EC
- GAS Directive 2009/142/EC (Nur N<sup>\*\*\*\*\*</sup> und WN3...)
- CE Marking Directive 93/68/EEC
- RoHS Directive 2002/95/EC
- WEEE Directive 2002/96/EC
- MD Directive 2006/42/EC

## Déclaration de conformité CE

Nous, Electrolux Laundry Systems Sweden AB  
SE-341 80 Ljungby, Suède

déclarons sous notre seule et unique responsabilité que le produit des type et numéro de série indiqués ci-dessus est fabriqué conformément aux directives UE suivantes:

- LVD Directive 2006/95/EC
- EMC Directive 2004/108/EC
- GAS Directive 2009/142/EC (N<sup>\*\*\*\*\*</sup> et WN3... uniquement)
- CE Marking Directive 93/68/EEC
- RoHS Directive 2002/95/EC
- WEEE Directive 2002/96/EC
- MD Directive 2006/42/EC

## Declaración de conformidad CE

Electrolux Laundry Systems Sweden AB  
con sede en SE-341 80 Ljungby, Suecia

declara bajo su exclusiva responsabilidad que el producto cuyo tipo se especifica en el encabezado se ha fabricado conforme a las siguientes directivas:

- LVD Directive 2006/95/EC
- EMC Directive 2004/108/EC
- GAS Directive 2009/142/EC (vale sólo N<sup>\*\*\*\*\*</sup> y WN3)
- CE Marking Directive 93/68/EEC
- RoHS Directive 2002/95/EC
- WEEE Directive 2002/96/EC
- MD Directive 2006/42/EC

## Erklæring om EU-overensstemmelse

Vi, Electrolux Laundry Systems Sweden AB  
SE-341 80 Ljungby, Sverige

erklærer på eget ansvar, at produktet med typebetegnelse som angivet er fremstillet i overensstemmelse med følgende EU-direktiver:

- LVD Directive 2006/95/EC
- EMC Directive 2004/108/EC
- GAS Directive 2009/142/EC (gælder kun N<sup>\*\*\*\*\*</sup> og WN3...)
- CE Marking Directive 93/68/EEC
- RoHS Directive 2002/95/EC
- WEEE Directive 2002/96/EC
- MD Directive 2006/42/EC

## EY-Vaatimustenmukaisuusvakuutus

Me, Electrolux Laundry Systems Sweden AB  
SE-341 80 Ljungby, Ruotsi

vakuutamme yksinomaan omalla vastuullamme, että tuote, jonka tyyppitunnus lukee yllä, on valmistettu seuraavien [EU]-direktiivien mukaisesti:

- LVD Directive 2006/95/EC
- EMC Directive 2004/108/EC
- GAS Directive 2009/142/EC (vain N<sup>\*\*\*\*\*</sup> ja WN3...)
- CE Marking Directive 93/68/EEC
- RoHS Directive 2002/95/EC
- WEEE Directive 2002/96/EC
- MD Directive 2006/42/EC

## EF-samsvarserklæring

Vi, Electrolux Laundry Systems Sweden AB  
SE-341 80 Ljungby, Sverige,

erklærer på eget ansvar at dette produktet, med typebetegnelse og produktionsnummer som angitt nedenfor, er produsert i samsvar med bestemmelsene i følgende direktiver:

- LVD Directive 2006/95/EC
- EMC Directive 2004/108/EC
- GAS Directive 2009/142/EC (gjelder bare N<sup>\*\*\*\*\*</sup> og WN3...)
- CE Marking Directive 93/68/EEC
- RoHS Directive 2002/95/EC
- WEEE Directive 2002/96/EC
- MD Directive 2006/42/EC

## EG-Conformiteitsverklaring

Wij, Electrolux Laundry Systems Sweden AB  
SE-341 80 Ljungby, Zweden

verklaaren hierbij op eigen verantwoordelijkheid dat het product van het type en met het serienummer zoals hieronder vermeld, is vervaardigd conform de volgende normen:

- LVD Directive 2006/95/EC
- EMC Directive 2004/108/EC
- GAS Directive 2009/142/EC (alleen N<sup>\*\*\*\*\*</sup> en WN3...)
- CE Marking Directive 93/68/EEC
- RoHS Directive 2002/95/EC
- WEEE Directive 2002/96/EC
- MD Directive 2006/42/EC

## Dichiarazione CE di conformità

Noi, Electrolux Laundry Systems Sweden AB  
SE-341 80 Ljungby, Svezia

dichiariamo sotto la nostra intera responsabilità che il prodotto del tipo specificato sopra è conforme alle seguenti direttive [UE]:

- LVD Directive 2006/95/EC
- EMC Directive 2004/108/EC
- GAS Directive 2009/142/EC (solo N<sup>\*\*\*\*\*</sup> e WN3...)
- CE Marking Directive 93/68/EEC
- RoHS Directive 2002/95/EC
- WEEE Directive 2002/96/EC
- MD Directive 2006/42/EC

## Declaração CE de conformidade

Nós, Electrolux Laundry Systems Sweden AB  
SE-341 80 Ljungby, Suécia

declaramos sob nossa inteira responsabilidade que o produto com os números de série e de tipo abaixo indicados é fabricado em conformidade com as seguintes diretivas [UE]:

- LVD Directive 2006/95/EC
- EMC Directive 2004/108/EC
- GAS Directive 2009/142/EC (apenas N<sup>\*\*\*\*\*</sup> e WN3...)
- CE Marking Directive 93/68/EEC
- RoHS Directive 2002/95/EC
- WEEE Directive 2002/96/EC
- MD Directive 2006/42/EC

## ΔΗΛΩΣΗ ΠΙΣΤΟΤΗΤΑΣ ΕΚ

H, Electrolux Laundry Systems Sweden AB  
SE-341 80 Ljungby, Σουηδία

δηλώνει με αποκλειστική της ευθύνη ότι το προϊόν του ανωτέρω αναφερόμενου τύπου κατασκευάζεται σύμφωνα με τις ακόλουθες οδηγίες της Ευρωπαϊκής Ένωσης:

- LVD Directive 2006/95/EC
- EMC Directive 2004/108/EC
- GAS Directive 2009/142/EC (N<sup>\*\*\*\*\*</sup> και WN3... μόνο)
- CE Marking Directive 93/68/EEC
- RoHS Directive 2002/95/EC
- WEEE Directive 2002/96/EC
- MD Directive 2006/42/EC

## CE megfeleloségi nyilatkozat

Mi, az, Electrolux Laundry Systems Sweden AB  
SE-341 8 Ljungby, Svédország

felelőségünk teljes tudatában kijelentjük, hogy az alább megadott típusú termék gyártása a következő EU-irányelvekkel összhangban történik:

- LVD Directive 2006/95/EC
- EMC Directive 2004/108/EC
- GAS Directive 2009/142/EC (csak az N<sup>\*\*\*\*\*</sup> és WN3... esetén)
- CE Marking Directive 93/68/EEC
- RoHS Directive 2002/95/EC
- WEEE Directive 2002/96/EC
- MD Directive 2006/42/EC

Ljungby 2010.08.16



**Franco Panno**

Vice President Technical Operations

471 1531-43/21

Page 1/2

**Translation table for model name to type of approval**

Commercial name	Type
W455H	W.55H.
W465H	W3...
W475H	W3...
W4105H	W3...
W4130H	W3...
W4180H	W3...
W4240H	W3...
W4300H	W3...
FOM71 CLS	W3...
WB4130H	W3...
WB4180H	W3...
PW9	W3...
W475S	W3...
W485S	W3...
W4105S	W3...
W4130S	W3...
W4180S	W3...
W4250S	W3...
W4330S	W3...
W475N	W3...
W485N	W3...
W4105N	W3...
W4130N	W3...
W4180N	W3...
W4250N	W3...
W4330N	W3...
WD4130H	WN3...
WD4240H	WN3...
W4400H	W4.H.
W4600H	W4.H.
W4850H	W4.H.
W41100H	W4.H.
W4280X	EXSM.X.
W4350X	EXSM.X.
W4600X	EXSM.X.
C240	H1...
C260	H1...
C240R	H1...
C260R	H1...
C290R	H1...
T4130	N1130..
T4190	N1190..
PD9	N1190..
T4250	N2...
T4350	N2...
T4300S	N3...
T4290	N4...
T4530	N4...
T4650	N4...
T4900	N4...
T41200	N4...
T4900CR	N4...
T41200CR	N4...
T4300LE	N5...

Ljungby 2010.08.16



**Franco Panno**  
Vice President Technical Operations



#### **Skrotning av maskin**

När maskinen inte längre skall användas måste den lämnas till en återvinningsstation för destruktion. Många detaljer i maskinen går att återanvända, men den innehåller även annat material som måste tas om hand på ett korrekt sätt. Lämna därför aldrig maskinen eller delar av maskinen i hushållsavfallet, eftersom det kan leda till hälsorisker eller skador på miljön.

#### **Scrapping of machine**

When the machine is no longer to be used, it must be submitted to a recycling facility for destruction. The majority of the components in the machine can be reused, but it also contains other material that must be taken care of in the correct way. Therefore, never mix the machine or its parts with domestic waste as this may lead to health hazards or damage to the environment.

#### **Entsorgung des Geräts**

Wenn das Gerät nicht länger im Gebrauch ist, muss dieses einer Recyclingstation zur Entsorgung zugeführt werden. Viele Komponenten des Geräts sind recyclingfähig, enthalten aber auch Materialien, die vorschriftsmäßig entsorgt werden müssen. Entsorgen Sie daher das Gerät oder Geräteteile niemals im Hausmüll, da dies Gefahren für die Gesundheit oder Umweltschäden nach sich ziehen kann.

#### **Mise au rebut de machine**

Lorsque la machine n'est plus utilisée, elle doit être déposée à une installation de recyclage pour y être détruite. La majorité des composants de la machine peuvent être réutilisés mais celle-ci contient également d'autres matériaux qui doivent être traités correctement. C'est pourquoi vous ne devez jamais mélanger la machine ou ses pièces avec les ordures ménagères, risque de pollution pour l'environnement ou la santé.

#### **Desguace de la máquina**

Cuando la máquina no tenga que utilizarse más, ha de entregarse a una instalación de destrucción para su reciclado. La mayor parte de sus componentes pueden volver a utilizarse, pero consta también de otros materiales que han de ser tratados de la manera correcta. Por esa razón nunca mezclar la máquina ni sus partes con la basura doméstica pues esto podría constituir un peligro para la salud o dañar el medio ambiente.

#### **Bortskaffelse af maskinen**

Når maskinen ikke længere er i brug, skal den afleveres til destruktion på en genbrugsstation. Mange dele i maskinen kan genanvendes, men den indeholder også andre materialer, der skal håndteres korrekt. Smid derfor ikke maskinen eller dele af den ud sammen med husholdningens almindelige affald, da det kan være forbundet med sundhedsrisiko eller give miljøskader.

#### **Koneen hävittäminen**

Kun koneita ei enää käytetä, se pitää luovuttaa kierrätyskeskukseen tuhottavaksi. Suurinta osaa koneen osista voidaan käyttää uudelleen, mutta se sisältää myös materiaaleja, jotka pitää käsitellä asianmukaisesti. Älä sen vuoksi koskaan laita koneita tai sen osia kotitalousjätteen sekaan, sillä se saattaa aiheuttaa terveysriskejä tai vahinkoa ympäristölle.

#### **Skrotning av maskin**

Når maskinen ikke lenger skal brukes, må den leveres til en gjenvinningsstasjon for destruksjon. Det går an å gjenbruke mange deler av maskinen, men den inneholder også annet materiale som man må ta hånd om på riktig måte. Legg derfor aldri maskinen eller deler av maskinen i husholdningsavfallet, siden det kan føre til helse- eller miljøskader.

#### **Afdanken van de machine**

Als de machine niet langer gebruikt gaat worden, moet deze ter vernietiging worden aangeboden bij een recyclinginrichting. De meeste componenten van de machine kunnen worden hergebruikt, maar hij bevat ook ander materiaal dat op een juiste wijze moet worden behandeld. Daarom de machine of zijn onderdelen nooit bij het huisvuil zetten, want dat kan leiden tot gezondheidsrisico's of schade aan het milieu.

#### **Rottamazione della macchina**

Quando la macchina non può più essere utilizzata, deve essere affidata a un centro di riciclaggio che ne effettui la rottamazione. La maggior parte dei componenti della macchina sono riciclabili, ma ce ne sono anche alcuni che devono essere smaltiti in modo appropriato. Perciò, non mischiare mai la macchina o parti di essa con i normali rifiuti domestici, poiché ciò potrebbe comportare rischi per la salute o per l'ambiente.

#### **Złomowanie maszyny**

Wycofaną z użytkowania maszynę należy przekazać do zakładu utylizacji w celu złomowania. Większość podzespołów maszyny nadaje się do powtórnego wykorzystania, lecz zawiera ona także inne materiały, z którymi należy postępować w odpowiedni sposób. Z tego powodu niedozwolone jest łączenie maszyny lub jej części z odpadami domowymi, gdyż może to prowadzić do zagrożenia zdrowia lub szkody dla środowiska.

#### **Vyřazení přístroje**

Přístroj, který již nebude používán, by měl být odevzdán k likvidaci do ekodvora. Většina součástí přístroje může být opětovně použita, některé ale vyžadují likvidaci přesně daným způsobem. A proto nikdy nemíchejte dohromady přístroje nebo jejich části s domácím odpadem, mohlo by to vést ke zdravotním rizikům nebo k poškození životního prostředí.

#### **Οριστική απόσυρση μηχανήματος**

Όταν το μηχάνημα δεν προορίζεται για περαιτέρω χρήση, θα πρέπει να οδηγείται σε εγκατάσταση ανακύκλωσης για καταστροφή. Το μεγαλύτερο ποσοστό των εξαρτημάτων του μηχανήματος μπορεί να χρησιμοποιηθεί ξανά, αλλά το μηχάνημα περιλαμβάνει και άλλα υλικά η διαλογή των οποίων θα πρέπει να πραγματοποιείται με τον κατάλληλο τρόπο. Κατά συνέπεια, μην αναμειγνύετε ποτέ το μηχάνημα ή τα εξαρτήματά του με οικιακά απορρίμματα καθώς αυτό μπορεί να αποβεί επικίνδυνο για την υγεία ή επιβλαβές για το περιβάλλον.

*Thinking of you*

 **Electrolux**

Electrolux Laundry Systems Sweden AB  
341 80 Ljungby, Sweden  
[www.electrolux.com/laundrysystems](http://www.electrolux.com/laundrysystems)

**Share more of our thinking at [www.electrolux.com](http://www.electrolux.com)**